

OPERATING INSTRUCTION

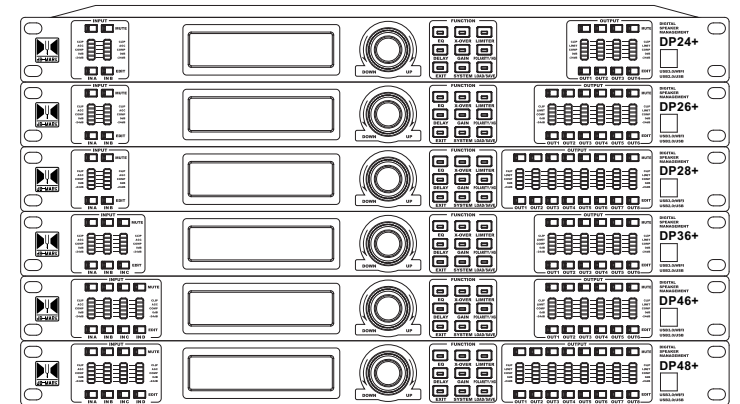

**MODEL: DP24+
DP26+
DP28+
DP36+
DP46+
DP48+**

DISTRIBUTED BY



DIGITAL SPEAKER MANAGEMENT

Attention

Warning: To prevent the short circuit, keep the device away from any place of humidity.

Turn off the device immediately in case of water damage and find the right technician for reparation.

Do not open the device yourself unless by the authorized technician.

When you see the exclamation Mark flashing, the device is also with high voltage and the alert should be on.

When you see the arrowhead signal flashing, the device is with high voltage.

Please do not touch the device for any reason.

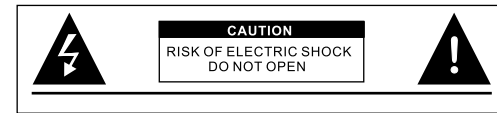

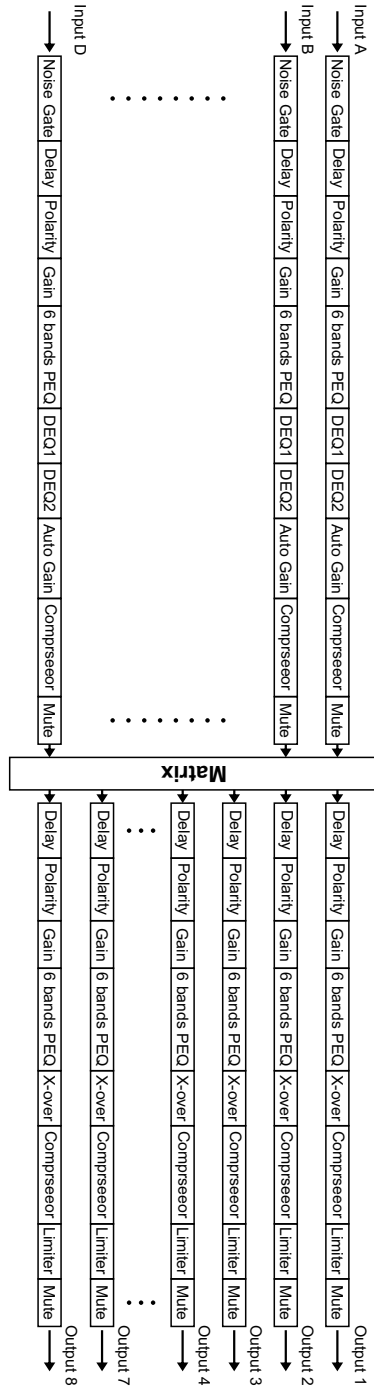

Directory

Part 1: The connection methods of device and computer

- 1.1 Single device connects with computer via USB and not need driver ... (01)
- 1.2 Multiple devices connecting with computer via UTWR1 (01)
- 1.3 Method of single device connecting with central control device (03)
- 1.4 Internet connection way (Including wifi) (04)
- 1.5 Terminal checking method (16)
- 1.6 Parameter checking/parameter modify method (19)

Part 2: Operating instruction

- 2.1 The symbol explanation (30)
- 2.2 Functions & Characteristics (30)
- 2.3 Front panel instruction (31)
- 2.4 Rear panel instruction (33)
- 2.5 Technical parameter (34)
- 2.6 Editing method for input & output channels (35)
- 2.7 System Menu (36)
- 2.8 Program operating (39)
- 2.9 Others (40)

Part 3: Software installing & instruction

- 3.1 The installation of RS485 driver in UTWR1 model (41)
- 3.2 Installing of software (41)
- 3.3 Solutions for the connection error (42)
- 3.4 Software interface instruction (43)
 - 3.4.1 The 5 areas in software interface (43)
 - 3.4.2 Software connection (44)
 - 3.4.3 About Software (45)
 - 3.4.3.1 Instruction of input (45)
 - 3.4.3.2 Instruction of output (46)
 - 3.4.3.3 Using/saving/of data (46)
 - 3.4.3.4 ID number modifying & ID selecting in multiple devices connection (47)
 - 3.4.3.5 Modify the symbols on device`s display screen (48)
 - 3.4.3.6 Function & System locked (49)
 - 3.4.3.7 Checking and backup for the current data of device (51)
 - 3.4.3.8 Channels editing area & channels parameter details adjusting area (52)
- 3.5 Device software version updating (60)
- 3.6 Central control order generator (61)
- Appendix 1 signal processing pic (63)

Part 1: The connection methods of device and computer

1.1 Single device connects computer via USB and no need driver

Using the equipped USB cable to connect the PC USB port with device USB port, then turn on the power and wait for the device starting. This connecting method is suitable for PC connect with single device in short distance.

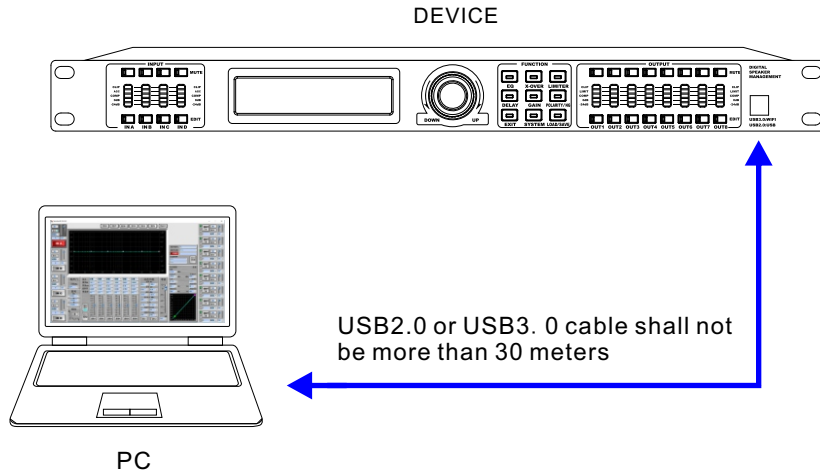

1.2 Multiple devices connecting with computer via UTWR1

(1) Many units (max. 250 units) can be parallel connected with a standard network cable through the RS485 terminal at the rear panel, and then connect it to PC (Pic1.2.3)

(NOTE: Each device ID number should be different. If the ID numbers are same, it can not be connected to the PC completely.)

(2) Computer connects with device via USB to UTWR1 to device. The driver is the same as the USB driver.

(3) The method of how to set up ID number in the device: Press the key SYSTEM, and the menu will be displayed as below pic 1.2.1



Pic 1.2.1

Click [system] to popup a window as below

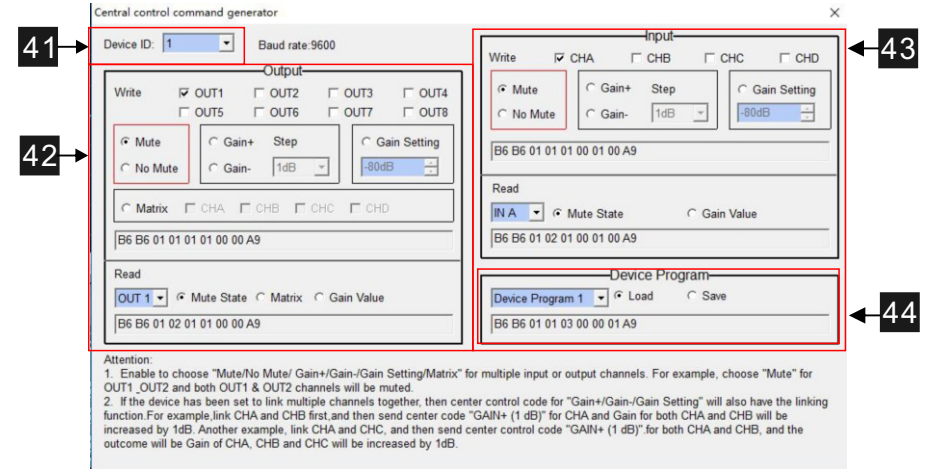

Pic 3.6.3

- 41 When connecting multiple devices to a computer, put in here the ID of the device to be connected.
- 42 Output channel central control code automatic generation area
Select options here to operate actions for each output channel gate, including mute, gate, matrix.
- 43 Input channel central control code automatic generation area
Select options here to operate action for the input channel gate, such as mute, gain setting, transfer, store.
- 44 Central Control Cold
Here it refers to the automatically generated central control code.

3.6 Central Control Order Generator

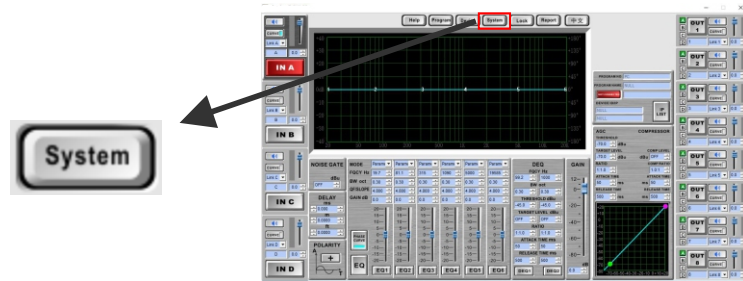

Pic 3.6.1

Click [system] to popup a window as below

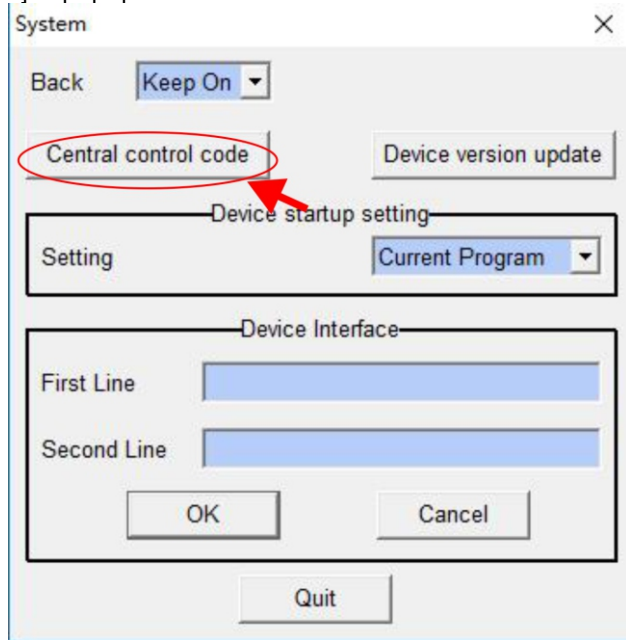

Pic 3.6.2

Press the encoder to enter into the next menu (as below pic 1.2.2)

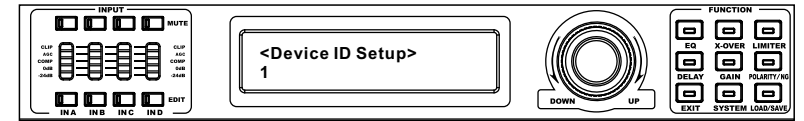

Pic 1.2.2

Select the ID number by rotating encoder, press encoder, and shows the current ID No.. The method is suitable for PC remote control multiple devices, PC can choose 11 ID No. to connect 1 device in one time, Remote control can be up to 1500m.

ID No. selection and even connection method will be described as below.

(Note: Some PC, there is no standard RS485 serial interface, typically only a USB port, so you need to convert a standard RS485 serial interface to allow PC and devices to communicate via a standard RS485 serial interface).

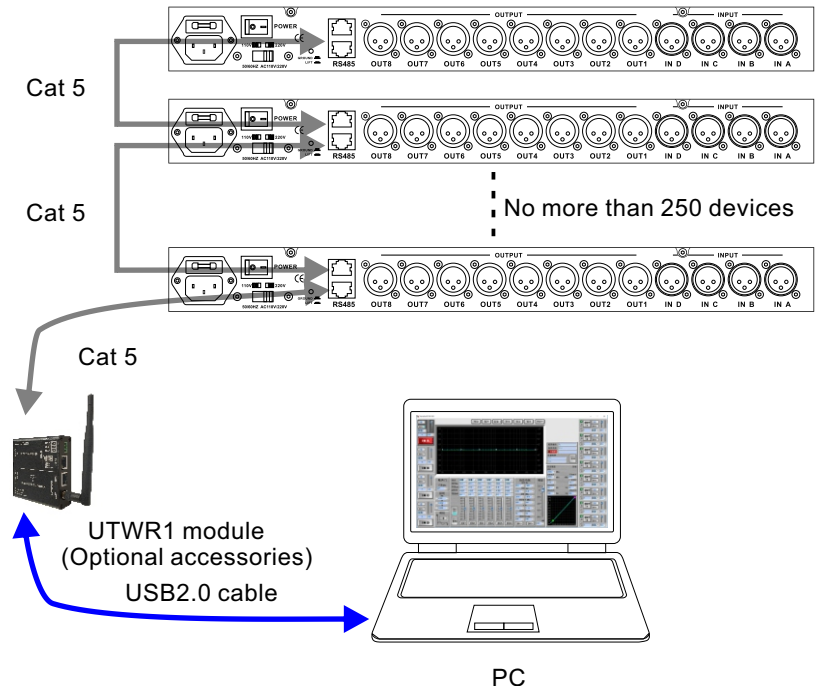

Pic 1.2.3

1.3 Method of single device connecting with central control device

1.3.1 Control code shows

Central control code (for RS485 port)
 (note: 485 baud rate 9600,data bit 8,stop bit 1,check bit none)
 Applicable version:Z-DV1.00 or the latest version.

One frame data form: frame head(2)+device ID(1)+frame type(1)+function type(1)
 +channel No.(2)+parameter value(1)+frame end(1)

Description:

Sending 9 bytes data pack, the bytes volume is fixed.

- 1.When frame type is writing, after device operation succeeded and returned to the sending order this is read. And now it has returned to the specific state frame data.
- 2.After sending a frame data pack to the device and do not get any respond, please check the connection or check if it is the right data pack.
- 3.To ensure the normal communication, shall make sure receiving the data pack or operating succession before sending the next data pack.

Make the below orders to output channel 1

- 1, mute
B6 B6 01 01 01 01 00 00 A9
- 2.non-mute
B6 B6 01 01 01 01 00 01 A9
- 3.increase gain
B6 B6 01 01 05 01 00 01 A9
- 4.decrease gain
B6 B6 01 01 06 01 00 01 A9
- 5.set up gain as -80dB
B6 B6 01 01 04 01 00 00 A9
- 6.Set up input channel A as input source
B6 B6 01 01 02 01 00 01 A9

Make the below orders to input channel A

- 1.mute
B6 B6 01 01 01 00 01 00 A9
- 2.non-mute
B6 B6 01 01 01 00 01 01 A9
- 3.increase gain
B6 B6 01 01 05 00 01 01 A9
- 4.decrease gain
B6 B6 01 01 06 00 01 01 A9
- 5.set up gain as -80dB
B6 B6 01 01 04 00 01 00 A9
- 6.Set up input channel A as input source
B6 B6 01 01 04 00 01 00 A9

Make the below orders to output channel 1

- 1.read mute state
B6 B6 01 02 01 01 00 00 A9
- 2.read matrix setting
B6 B6 01 02 02 01 00 00 A9
- 3.read channel gain
B6 B6 01 02 04 01 00 00 A9

Make the below orders to input channel A

- 1.read mute state
B6 B6 01 02 01 00 01 00 A9
- 2.read channel gain
B6 B6 01 02 04 00 01 00 A9

Make the below orders to device operating program

- 1.call device program 1
B6 B6 01 01 03 00 00 01 A9
- 2.save device program 1
B6 B6 01 01 07 00 00 01 A9

3.5 Device software version updating

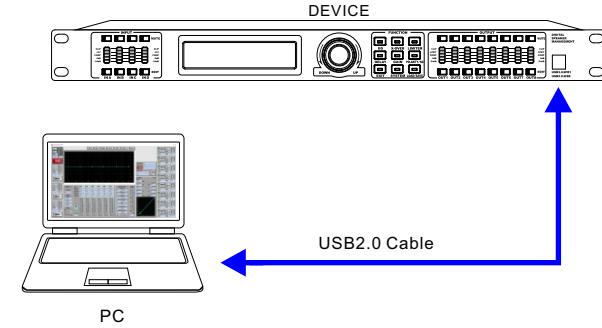

Pic 3.5.1

When the device software version does not match the version of the computer software. The device software version can be updated as follows:

(USB connection does not need to be installed, automatic identification)
 Step 1: Connect the computer and the processor as shown in Figure 3.5.1 (the USB cable is no longer than 30 meters).

Step 2: Open the software, click [Not Connected], then click "USB Connection", and the software is connected to the device.

Step 3: Click [System], then click [Device Version Update] as shown in Figure 3.5.2. Click [Browse File] as shown in Figure 3.5.3, open the file with the suffix .bin provided by our company.

Click [USB Update]. The device display interface is shown in Figure 3.5.4. Please be patient and do not operate the device during the update process . When the update is complete, the device will automatically restart. After the device is restarted, you can click the [EXIT] button on the device to view the current device version number.

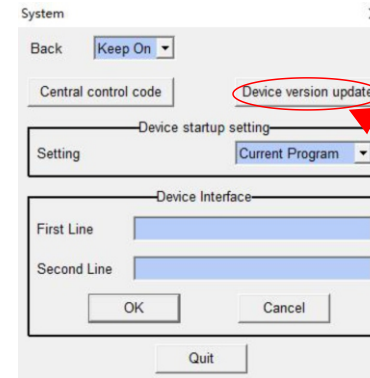

Pic 3.5.2

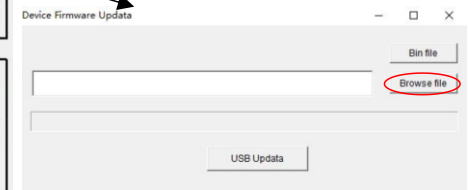

Pic 3.5.3

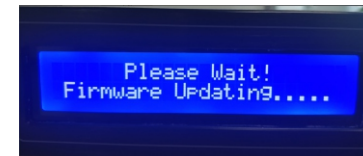

Pic3.5.4

2. Mouse click the up/down arrows (you can also press the up/down key on the keyboard, or roll the mouse wheel up and down) to adjust the ratio setting ranging 0.3~200ms, click arrows to adjust the response time before you finish the adjustment.

Release Time setting:

1. Position the mouse cursor to the Release Time input box, set the Release Time ranging 50~5000ms, delete the previous data and revise it into your needed data, then press Enter key to complete the adjustment.
2. Mouse click the up/down arrows (you can also press the up/down key on the keyboard, or roll the mouse wheel up and down) to adjust the Release Time ranging 50~5000ms, click arrows to adjust the release time before you finish the adjustment.

3.4.3.8.7 Gain Setting

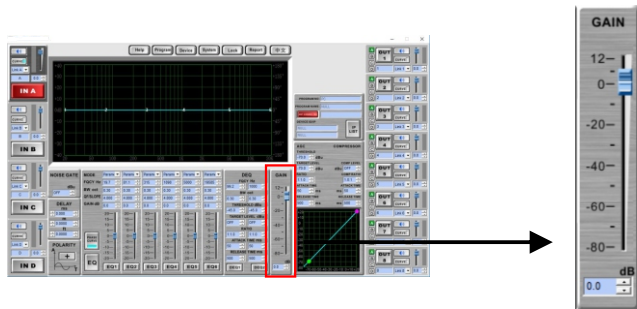

Pic 3.4.3.8.7.1

Gain Setting:

1. Roll the mouse down to the blue fader in the EQ box and click to adjust the gain values ranging -80dB~12dB, you can also press the left key of the mouse down to the adjusted value.
2. Position the mouse cursor to the Gain Adjustment input box, delete the previous data and revise it into your needed data ranging -80dB~12dB, then press Enter key to complete the adjustment.
3. Mouse click the up/down arrows (you can also press the up/down key on the keyboard, or roll the mouse wheel up and down) to adjust the gain of EQ, click arrows to adjust the values ranging -80dB~12dB before you finish the adjustment.

Notes:

1. Choosing multiple input or output channels as mute, non-mute, gain+, gain-, gain setting, matrix, these channels will work together. For example, if chose two channels set as mute then these two channels will be mute at the same time.
2. If setting the device as linking, the central control mode of gain+, gain-, gain setting will also have linking function. For example, Setting the device CHA, CHB as linking, then send CHA's gain+(1dB)control code, CHA's gain will increase 1dB, CHB's gain will increase 1dB too.
3. Device CHA, CHB is linking, sending CHA, CHB's gain+(1dB)control mode, then CHA, CHB, CHC's gain will increase 1dB in the same time.

1.3.2 UTWR1 Port connector cabling Introduction.

1. RJ-45 connector Distribution Map:

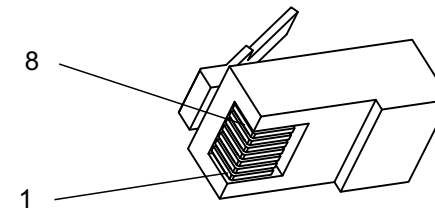

Pic1.3.2.1

2. RJ-45 connector cabling method as below:

- RJ-45 pin 5 : RT+ ;
- RJ-45 pin 4 : RT-;
- RJ-45 other pins : GND.

1.4 Internet connection way (Including wifi)

PC networking with 7 methods:

Note: You can connect internet with the UTWR1 module .

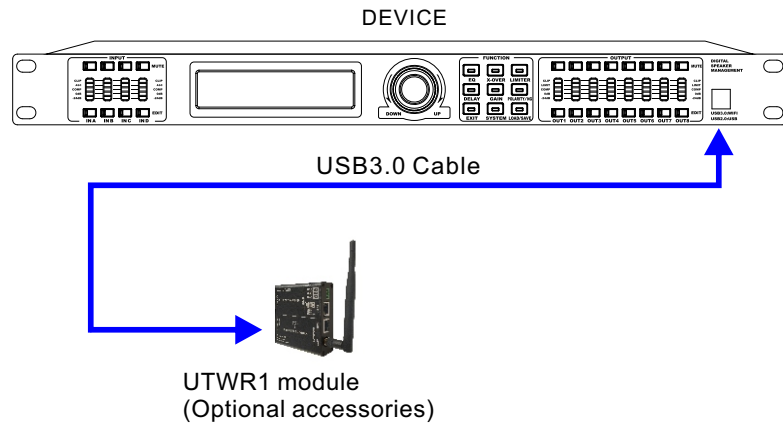

Pic 1.4.1

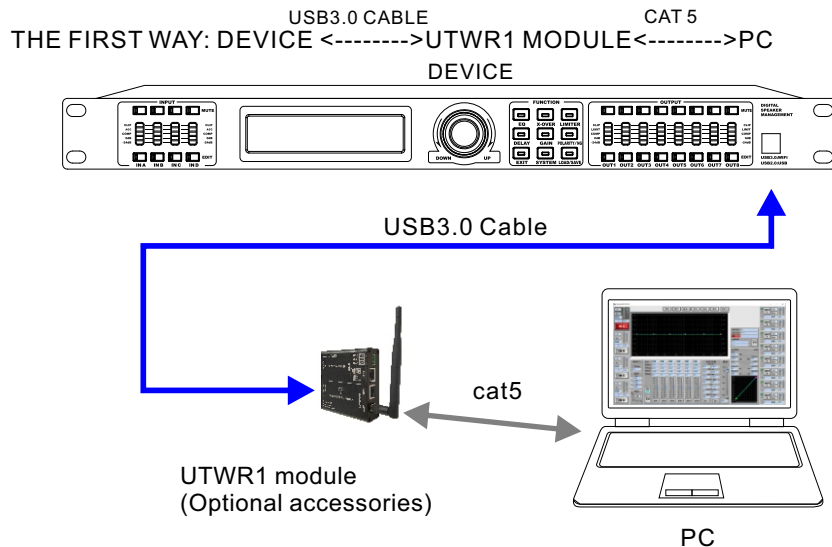

Pic 1.4.2

You should connect the device according to the picture you can see above. You must change the way to get the IP address to “automatically” in your PC. After this, you can connect the control software and device to PC.

Target Level Setting:

1. Click the small triangle tab of “Target Level” to choose levels ranging 0.05~3.00, then press Enter key to finish the adjustment.
2. Mouse click the up/down arrows (you can also press on the up/down keys on the keyboard, or roll the mouse wheel up and down) to adjust the target level ranging -80dBu~20dBu, click arrows to adjust target levels before you finish the adjustment.

Ratio Setting:

1. Mouse click the up/down arrows (you can also press the up/down key on the keyboard, or roll the mouse wheel up and down) to adjust the ratio setting ranging 1:1.0~1:20, click arrows to adjust the ratios before you finish the adjustment.

Response Time Setting:

1. Position the mouse cursor to the Response Time input box, set the response time ranging 0.3~200ms, delete the previous data and revise it into your needed data, then press Enter key to complete the adjustment.
2. Mouse click the up/down arrows (you can also press the up/down key on the keyboard, or roll the mouse wheel up and down) to adjust the ratio setting ranging 0.3~200ms, click arrows to adjust the response time before you finish the adjustment.

Release Time Setting:

1. Position the mouse cursor to Release Time input box, set the Release Time ranging 50~5000ms, delete the previous data and revise it into your needed data, then press Enter key to complete the adjustment.
2. Mouse click the up/down arrows (you can also press the up/down key on the keyboard, or roll the mouse wheel up and down) to adjust the Release Time ranging 50~5000ms, click arrows to adjust the release time before you finish the adjustment.

Compression Setting

Compression Level Setting:

1. Click the small triangle tab of “Compression Level dBu” to choose the levels ranging 40~20dBu, press Enter key to finish the adjustment.
2. Mouse click the up/down arrows (you can also press on the up/down keys on the keyboard, or roll the mouse wheel up and down) to adjust the target levels ranging -40~20dBu, click arrows to adjust the target levels before you finish the adjustment.

Compression ratio Setting:

1. Mouse click the up/down arrows (you can also press on the up/down keys on the keyboard, or roll the mouse wheel up and down) to adjust the compression ratios ranging 1.0:1~20.0:1, click arrows to adjust the target levels before you finish the adjustment.

Response Time Setting:

1. Position the mouse cursor to the Response Time input box, set the response time ranging 0.3~200ms, delete the previous data and revise it into your needed data, then press Enter key to complete the adjustment.

Ratio Setting:

1. Mouse click the up/down arrows (you can also press the up/down key on the keyboard, or roll the mouse wheel up and down) to adjust the ratio setting ranging 1:1.0~1:20, click arrows to adjust the ratios before you finish the adjustment.

Response Time Setting:

1. Position the mouse cursor to the Response Time input box, set the response time ranging 0.3~200ms, delete the previous data and revise it into your needed data, then press Enter key to complete the adjustment.
2. Mouse click the up/down arrows (you can also press the up/down key on the keyboard, or roll the mouse wheel up and down) to adjust the response time ranging 0.3~200ms, click arrows to adjust the response time before you finish the adjustment.

Release Time Setting:

1. Position the mouse cursor to the Release Time input box, set the Release Time ranging 50~5000ms, delete the previous data and revise it into your needed data, then press Enter key to complete the adjustment.
2. Mouse click the up/down arrows (you can also press the up/down key on the keyboard, or roll the mouse wheel up and down) to adjust the Release Time ranging 50~5000ms, click arrows to adjust the release time before you finish the adjustment.

3.4.3.8.6 Automatic Gain & Compression Setting

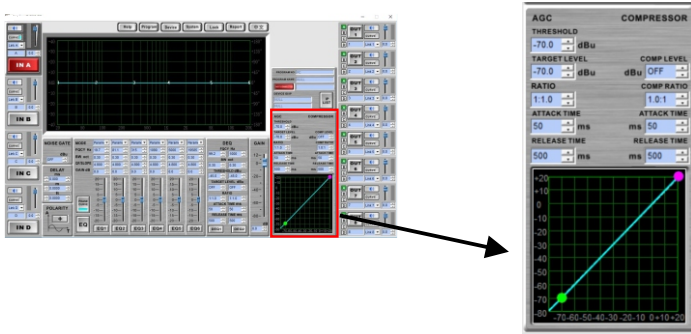

Pic 3.4.3.8.6.1

Automatic Gain Setting (Reference picture 3.4.3.8.6.1)

Threshold Value Setting:

1. Position the mouse cursor to the Threshold Adjustment input box, set the Threshold Values ranging -80dBu~20dBu, delete the previous data and revise it into your needed data, then press Enter key to complete the adjustment.
2. Mouse click the up/down arrows (you can also press the up/down key on the keyboard, or roll the mouse wheel up and down) to adjust the Threshold Values ranging -80dBu~20dBu, click arrows to adjust the threshold values before you finish the adjustment.

THE SECOND WAY: DEVICE <-----USB3.0 CABLE----->UTWR1 MODULE <-----WIRELESS----->PC

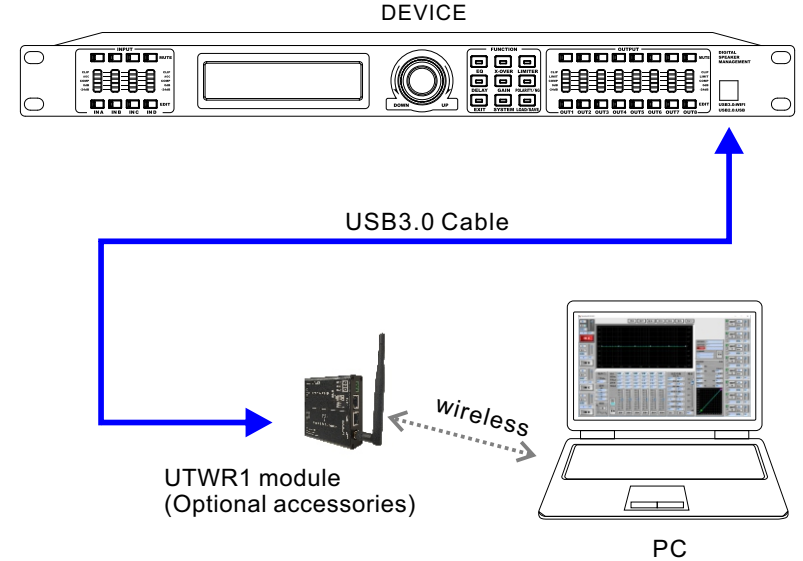

Pic 1.4.3

You need to change UTWR1 mode into AP mode, referring to 1.7.1.4

Steps under windows 7 system:

1. Open wifi connection to search the network name associated to the UTW1.

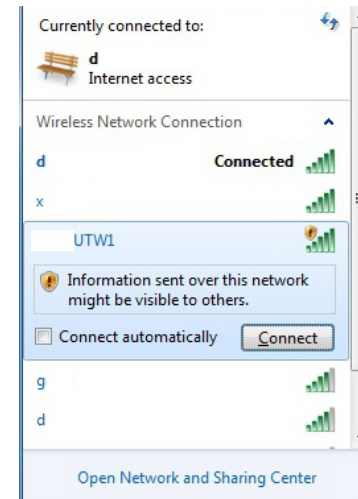

"UTW1-1.00-000001" name note
 UTW1: Model Denotation
 1.00: Said the version number
 000001: The said device random number (has uniqueness)

Pic 1.4.4

Connecting the relative network title. it will show as below, if you connect it well.



Pic 1.4.5

THE THIRD WAY: DEVICE <-----USB3.0 CABLE----->UTWR1MODULE<-----CAT 5----->ROUTER<-----CAT 5----->PC

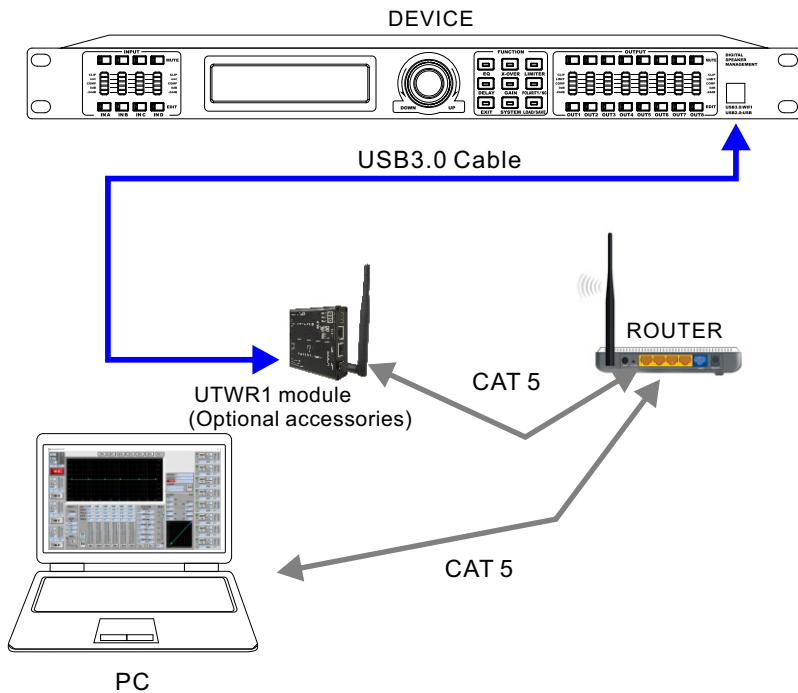

Pic 1.4.6

3.4.3.8.5 DEQ & DEQ parameter setting

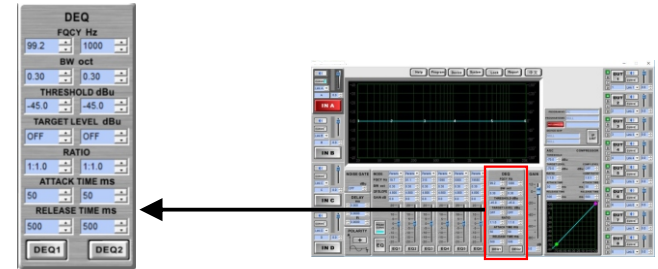

Pic 3.4.3.8.5.1

Click DEQ1 or DEQ2 to start Dynamic Equalizer DEQ function.

Frequency Setting:

1. Position the mouse cursor to the Frequency Adjustment input box, delete the previous data and revise it into your needed data, then press Enter key to complete the adjustment.
2. Mouse click the up/down arrows (you can also press on the up/down keys on the keyboard, or roll the mouse wheel up and down) to adjust the dynamic equalizer DEQ frequency, click the arrows to adjust the frequency channel number before you finish the adjustment.

Bandwidth Setting:

1. Bandwidth(oct),click the small triangle tab to choose bandwidths ranging 0.05~3.00,then press Enter key to finish the adjustment.
2. Mouse click the up/down arrows (you can also press on the up/down keys on the keyboard, or roll the mouse wheel up and down) to choose bandwidths ranging 0.05~3.00, click the arrows to adjust the band widths before you finish the adjustment.

Target level Setting:

1. Click the small triangle tab of "Target Level dBu" to choose levels ranging -45dBu ~15dBu, then press Enter key to finish the adjustment.
2. Mouse click the up/down arrows (you can also press the up/down key on the keyboard, or roll the mouse wheel up and down) to adjust target levels ranging -45dBu~15dBu, press the arrows to adjust the target levels before you finish the adjustment.

Click DEQ1 or DEQ2 to start Dynamic Equalizer DEQ parameter function

Threshold Value Setting:

1. Position the mouse cursor to the Threshold Adjustment input box, delete the previous data and revise it into your needed data, then press Enter key to complete the adjustment.
2. Mouse click the up/down arrows (you can also press the up/down key on the keyboard, or roll the mouse wheel up and down) to adjust threshold values ranging -45dBu~15dBu, press the arrows to adjust the threshold values before you finish the adjustment.

EQ illustration

model Setting:

There are four models (parameter, Lo-shelf, Hi-shelf, first-order all-pass, second-order all-pass), clicking down arrow choose low-key (high-key operating is similar with low-key). In this moment, the bandwidth and Q input column disappears and the slope dropdown shows meaning the model adjustment is finished.

Frequency Setting:

1. Cursor position to the EQ frequency adjusting input column and delete the original data then type into the data you need such as 40.5Hz, click enter will be done.
2. Clicking up and down arrow (or pressing it on the keyboard, or rolling the mouse) to adjust the EQ frequency. Clicking up arrow to adjust the value to 40.5Hz, adjusting finished.

Bandwidth Setting :

1. Cursor position to the EQ bandwidth adjusting input column and delete the original data then type into the data you need such as 0.30oct, click enter will be done.
2. Clicking up and down arrow (or pressing it on the keyboard, or rolling the mouse) to adjust the EQ bandwidth. Clicking up arrow to adjust the value to 0.30oct, adjusting finished.

Q value Setting:

1. Cursor position to the Q value adjusting input column and delete the original data then type into the data you need such as 4.800, click enter will be done.
2. Clicking up and down arrow (or pressing it on the keyboard, or rolling the mouse) to adjust the Q value of EQ 2. Clicking down arrow to adjust the value to 4.800, adjusting finished.

Gain Setting:

1. Cursor position to the gain of EQ adjusting input column and delete the original data then type into the data you need such as 0dB, click enter will be done.
2. Clicking up and down arrow (or pressing it on the keyboard, or rolling the mouse) to adjust the gain of EQ. Clicking up arrow to adjust the value to 0dB finishing the adjustment. Roll the mouse to the blue fader under the EQ volume, if the gain value is 0dB, you can keep press left key and roll it down to the value you needed.

EQ1 Setting:

Clicking "EQ1" button, when it is green means EQ start and when it is grey means EQ closed.

(note: Above instruction is suitable for EQ1-EQ6)

This connection, you might think device as within the local area network (LAN) a computer, computer and communications device through the LAN network to communicate.

Firstly, let the device enter into local area networks and offer its one static IP, referring to 1.7.1.1 AP.

Secondly, Connecting the device well, according to the picture above, and put PC and device into the same network segment (If the network gateway is 192.168.1.1, the gateway of PC and device must be the same) .

After this, you can connect control software and the device, referring to 3.4.2.

THE FOURTH WAY: $\overset{\text{USB3.0 CABLE}}{\text{DEVICE}} \longleftrightarrow \overset{\text{CAT 5}}{\text{UTWR1MODULE}} \longleftrightarrow \overset{\text{WIRELESS}}{\text{ROUTER}} \longleftrightarrow \text{PC}$

The connection mode and the third way is similar, only the router to your computer's connection to a wireless connection, any other settings.

THE FIFTH WAY: $\overset{\text{USB3.0 CABLE}}{\text{DEVICE}} \longleftrightarrow \overset{\text{WIRELESS}}{\text{UTWR1MODULE}} \longleftrightarrow \overset{\text{CAT 5}}{\text{ROUTER}} \longleftrightarrow \text{PC}$

The connection mode and the third way is similar, only the router to your computer's connection to a wireless connection, any other settings.

THE SIXTH WAY: $\overset{\text{USB3.0 CABLE}}{\text{DEVICE}} \longleftrightarrow \overset{\text{WIRELESS}}{\text{UTWR1MODULE}} \longleftrightarrow \overset{\text{WIRELESS}}{\text{ROUTER}} \longleftrightarrow \text{PC}$

The connection mode and the third way is similar, only the router to your computer's connection to a wireless connection, any other settings.

THE SEVENTH WAY:

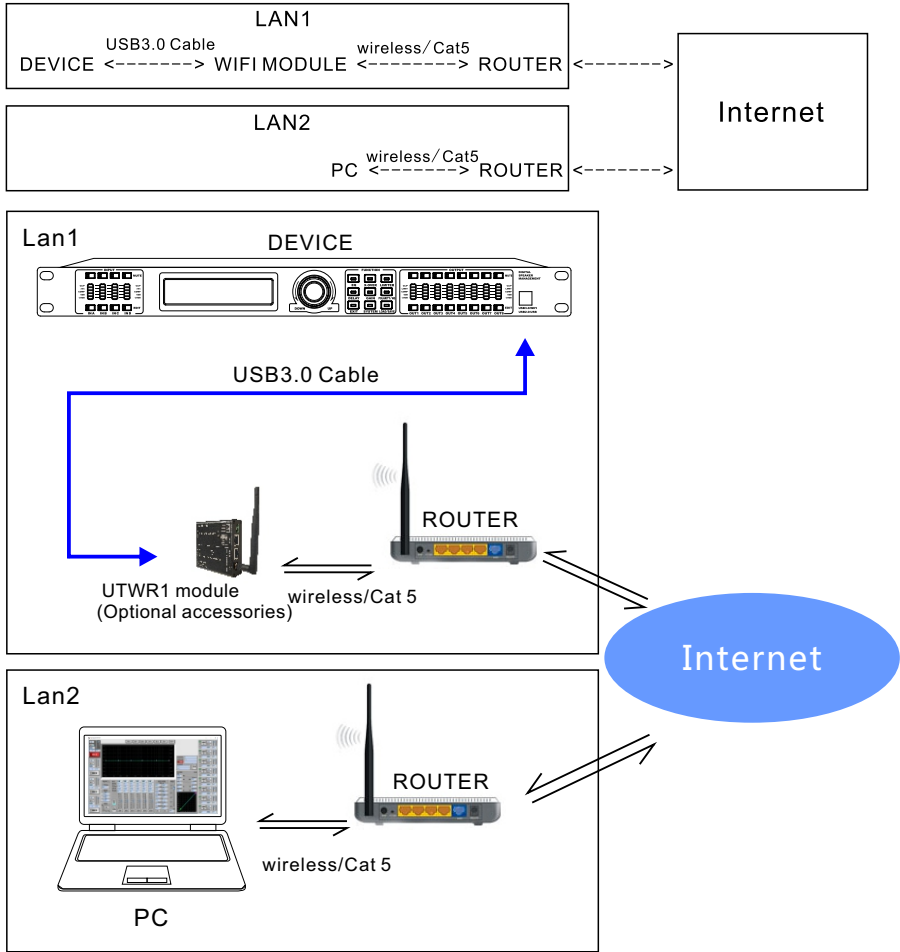

Pic 1.4.7

Third, fourth, fifth, sixth connection is on the same network segment of communication within the network when the device is in another network segment, or device in the distant place, 7 ways can be used to connect the communication.

Please connect the device well, referring to the picture above. The PC in local network 1 cannot be connected.

To the device in local network 1. Therefore, we need to set up as below

3.4.3.8.4 EQ setting

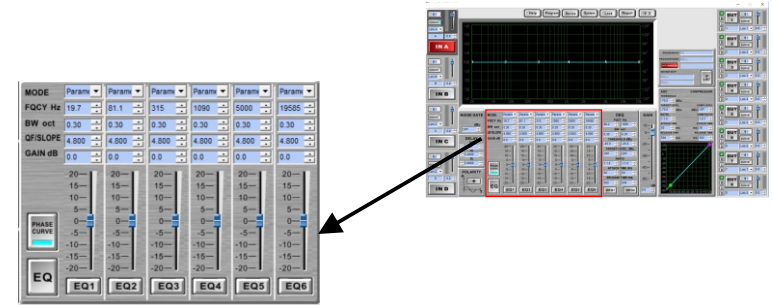

Pic 3.4.3.8.4.1

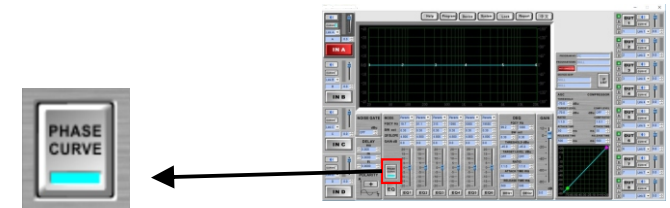

Pic 3.4.3.8.4.2

Polarity curve setting:

Click the "polarity curve" button in the red circle, when it is grey, it means the inner processor of device doesn't work. And when it is blue, it means the inner processor of device is modifying and adding the polarity curve of original signal.

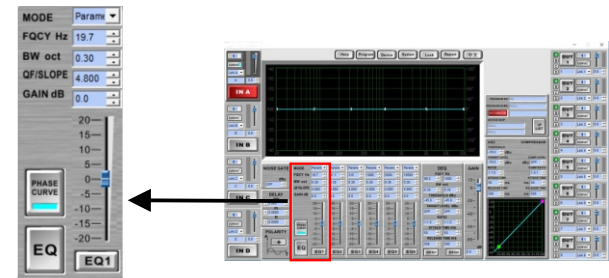

Pic 3.4.3.8.4.3

3.4.3.8.2 Delay setting

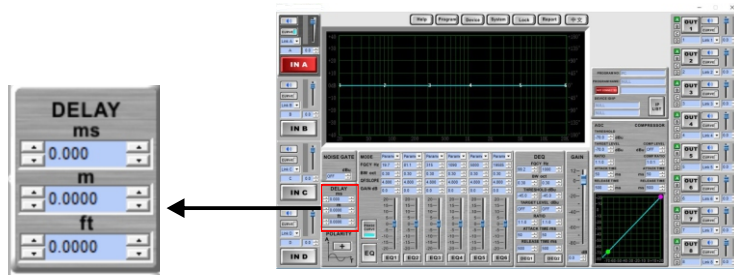

Pic 3.4.3.8.2.1

Delay Setting:

Open the inbiuld software in the device, set up the delay window function. When it shows 0.000, “millisecond”, “meter”, “feet” these do not have delay function. Click the up and down arrow to adjust the delay time of “millisecond”, “meter”, and “feet”. Any of “millisecond”, “meter”, and “feet”. adjusts its internal auto calculation the corresponding relation changes relatively. Millisecond adjusting range 0.000~1000 ms
 Meter adjusting range 0.000~331m
 Feet adjusting range 0.000~1086.011 feet

3.4.3.8.3 Polarity setting

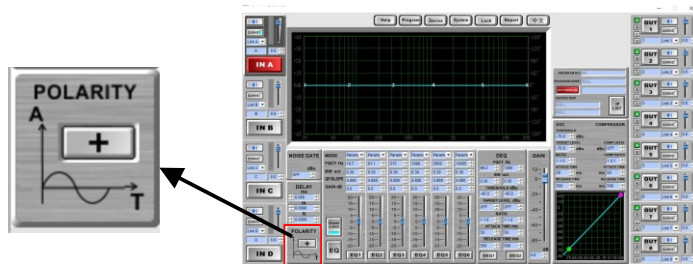

Pic 3.4.3.8.3.1

polarity Setting:

Open the polarity function in the red circle, in the polarity setting interface “+” indicates the original signal is in the same way as polarity, clicking it shows “-” indicates the original signal contrary to the polarity.

I. let UTWR1 module enter into local network .

Refer to picture 1.4.2 to connect UTWR1 to the computer . And then ,you can open internet browser input 10.10.100.254 into the address column .You can enter into UTWR1 module setup interface, acquiescent and use the user admin and password admin to load .

Parameters configuration begins :

a. Mode Selection

- 1.Click the “Mode Selection” .
- 2.Choose “station mode” (It makes device one client terminal, be connected into local network 1).
- 3.Select “transparent mode” .(Also, you can choose other mode)
- 4.Push “Apply”and save configuration parameters.

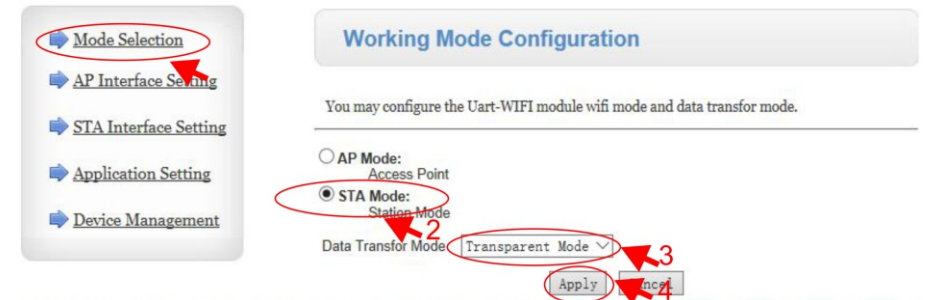

Pic 1.4.8

b. AP Interface Setting

1. Click "AP Interface Setting" at left column.
2. Fill in the network Name (SSID). (Naming the device)
3. Click "confirm" to save the configuration parameters.

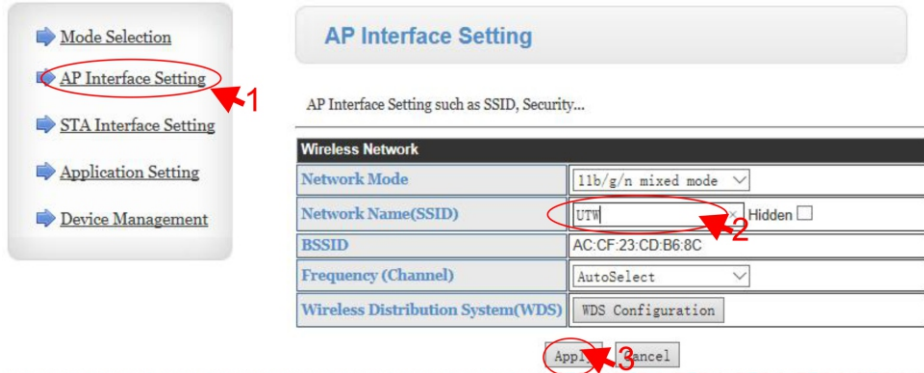

Pic 1.4.9

c. STA Interface Setting

1. Click "STA Interface Setting" at left column.
2. Click "Search" to find hot spot in local networks, choose one of them and fill in the password to enter into the local network 1.
3. Security Mode, Encryption Type, choosing default or any one you need.
4. Fill in wifi loading password.
5. Save configuration parameter by pushing the "Apply" Module IP address setup, select "STATIC (fixed IP)".
6. Setup IP address.
7. Setup subnet mask.
8. Setup subnet gateway.
9. Click "Apply" and save configuration parameter.

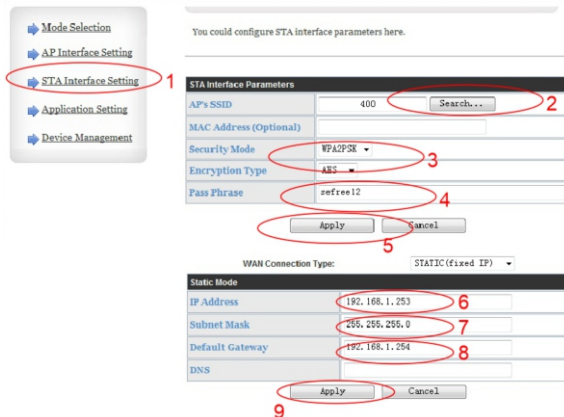

Pic 1.4.10

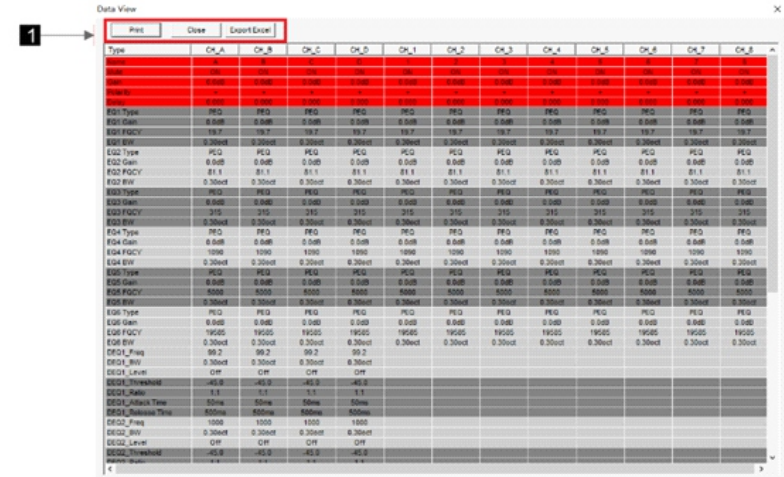

Pic 3.4.3.7.2

- 1 All data parameters of the current device can be printed or exported to Excel.

3.4.3.8 Channels editing area & channels parameter details adjusting area.

3.4.3.8.1 Noise gate setting

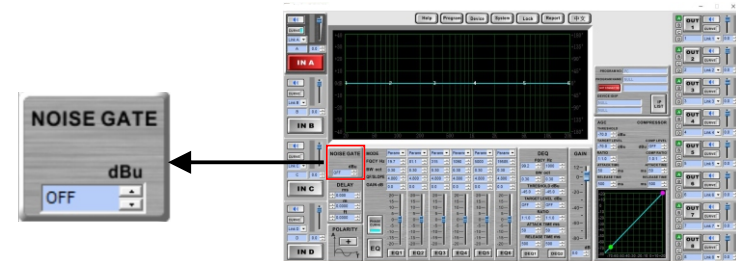

Pic 3.4.3.8.1.1

Noise gate Setting:

- In the noise gate setting interface, when it shows "off" state the noise gate is closed.
1. Click the up and down arrow (or press it on the keyboard, or roll the mouse up and down) can adjust OFF within (-120dBu) ~0dBu to achieve the adjustment.
 2. Cursor position to the noise gate adjusting input bar then type into OFF (-120dBu) ~0dBu, adjusting within this range. Delete the original data and change to the data needed then press "enter" the adjustment finished.

Step 1: Click on [System Lock]. Step 2: Click on [No Password]/[Set Password]
 Enter the following window:

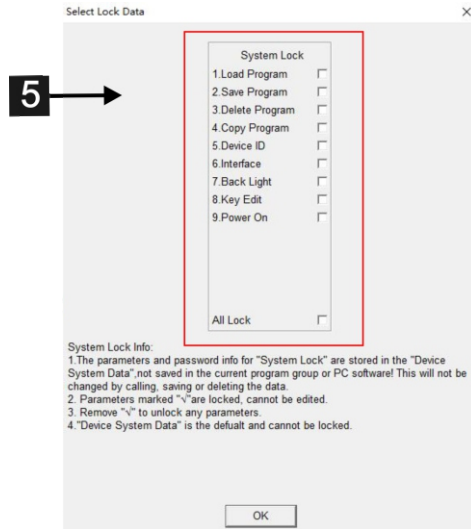

Pic 3.4.3.6.6

5 System Setting:
 1. Load Program, 2. Save Program, 3. Delete Program, 4. Copy Program,
 5. Device ID, 6. Interface, 7. Back light, 8. Key Edit, 9. Power On

3.4.3.7 Checking and backup for the current data of device.

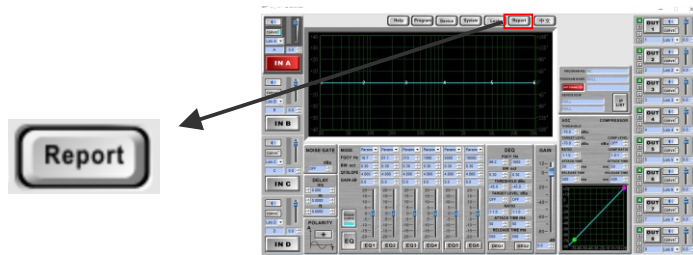

Pic 3.4.3.7.1

Click the button [Report], Display.

d. Application Setting

1. Click "Application Setting".
2. Please select network mode as "server".
3. Click "Apply" and save configuration parameters.

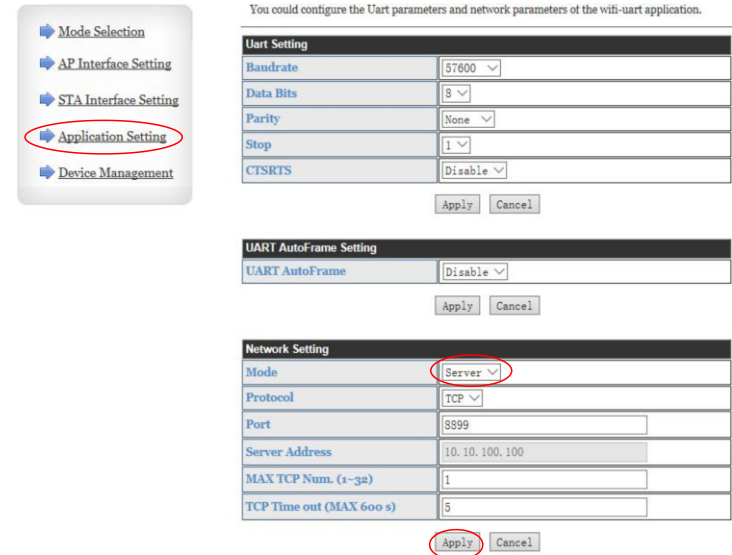

Pic 1.4.11

e. Device Management

1. Click "Device Management" at left column.
2. Push "Restart" and renew the changed parameter.

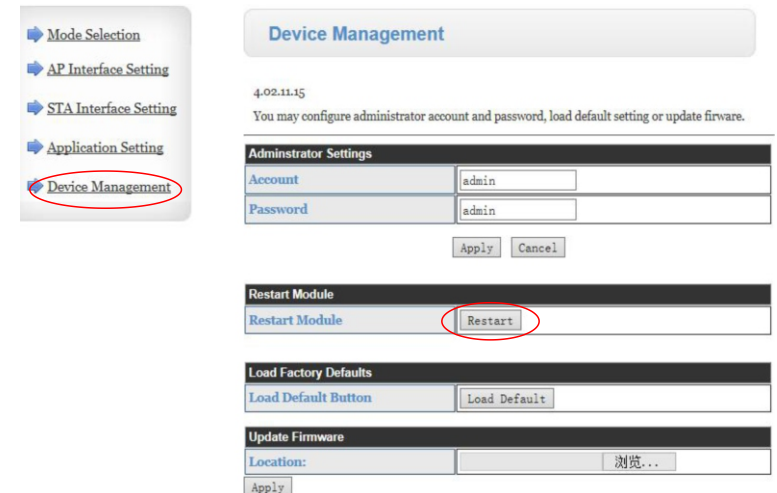

Pic 1.4.12

II. UTWR1 Module internet connecting setup

Open browser and input the gateway of Router at address column (192.168.1.1, etc.) To enter into Router setup interface .

Because there is firewall in router ,PC out of internet cannot visit the device in local LAN1.And you need to let router to open one IP address ,and the DMZ main device of router can realize it .

(DMZ is short of demilitarized zone ,which is buffer area between safe system and unsafe system).

Find out DMZ main device setup (Pic 1.4.13)

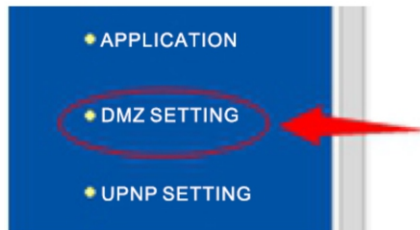

Pic 1.4.13

Setting of DMZ Host

As the picture below, DMZ STATE choose "Enabled"
The IP address of DMZ Host: fill in the static IP of the external wifi, save the parameters.

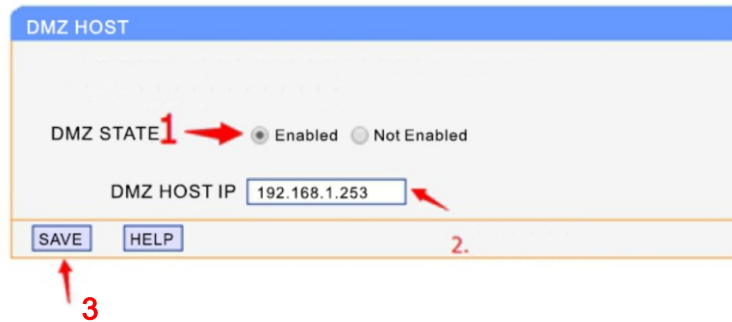

Pic 1.4.14

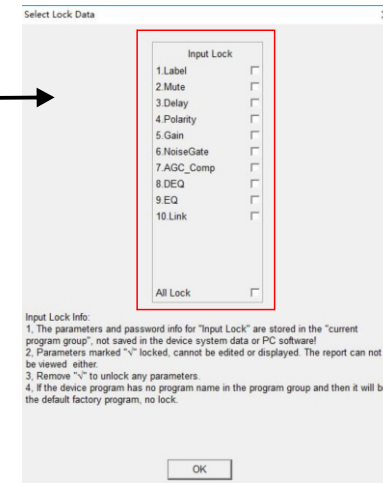

Pic 3.4.3.6.4

3 Input Setting:

1.Label,2.Mute,3.Delay,4.Polarity,5.Gain,6.NoiseGate,7.AGC_Comp, 8.DEQ,9.EQ,10.Link

(Note: After locking the EQ saved to the computer's on the data A, when the software calls the lock data A, the EQ is not adjustable or displayed, it needs to be unlocked, then you can adjust the EQ data)

Step 1: Click on [Output Lock]. Step 2: Click on [No Password]/[Set Password]

Enter the following window:

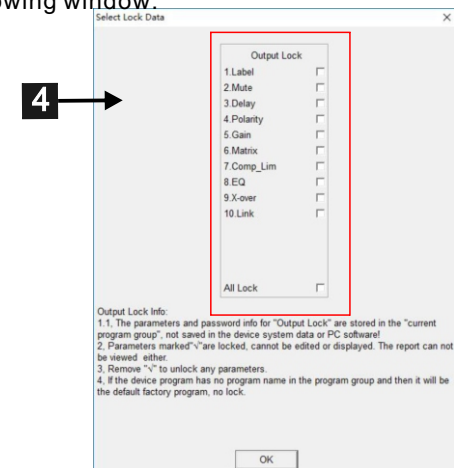

Pic 3.4.3.6.5

4 Output Setting:

1.Label,2.Mute,3.Delay,4.Polarity,5.Gain, 6.Matrix,7.Comp_Lim,8.EQ,9.X-over,10.Link

(Note: After locking the EQ saved to the computer's on the data A, when the software calls the lock data A, the EQ is not adjustable or displayed, it needs to be unlocked, then you can adjust the EQ data)

3.4.3.6 Function & System locked

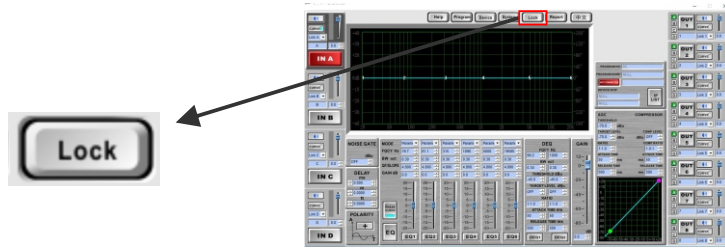

Pic 3.4.3.6.1

step 1: Click the button [Lock], Display.

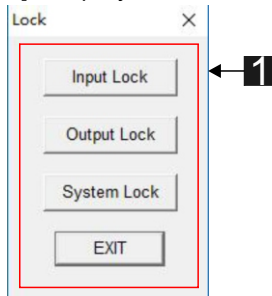

Pic 3.4.3.6.2

- 1 Select the items you want to set up here.
Step 2: Click one of the locking methods to pop up the following window.

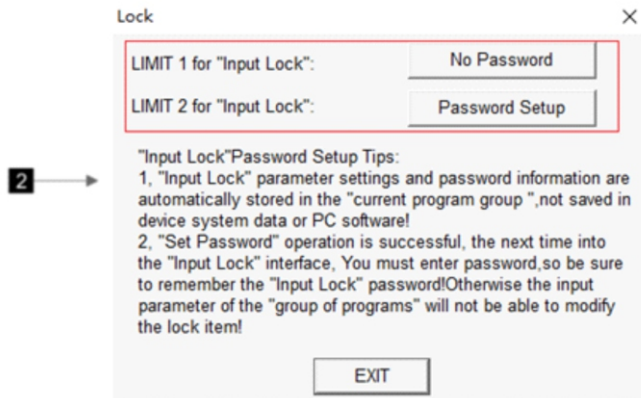

Pic 3.4.3.6.3

- 2 Click the button, NO PASSWORD or PASSWORD SETUP.

Step 1: Click on [Input Lock]. Step 2: Click on [No Password]/[Set Password]
Enter the following window:

Find the IP address of LAN (local area network) for Internet Click on the left column "operation situation".

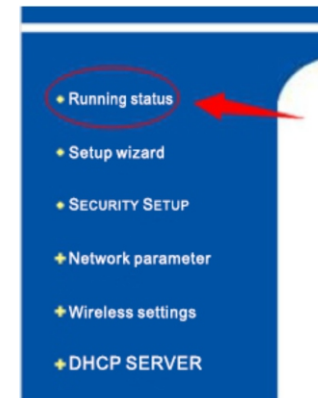

Pic 1.4.15

As the picture below, record the IP address of LAN for Internet

(Note: this IP address must be public IP, open the web site www.ip138.com, the web query to your IP address and your router outside the network IP address is the same, your IP address is public IP.)

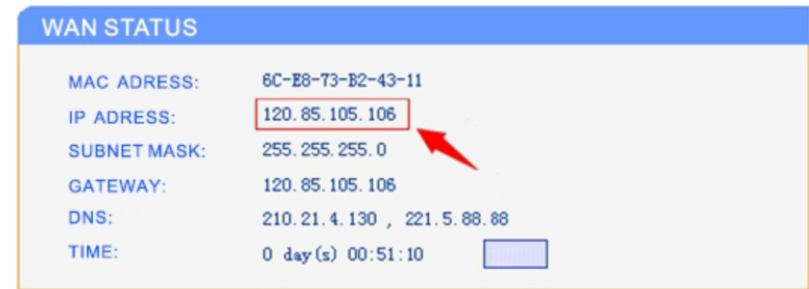

Pic 1.4.16

III. Use the software to connect the device by Internet

Open the software and click on “NOT CONNECTED”, as the picture below, in the “UTWR1:WIFI | TCP/IP”, fill in the Internet IP address of the device.

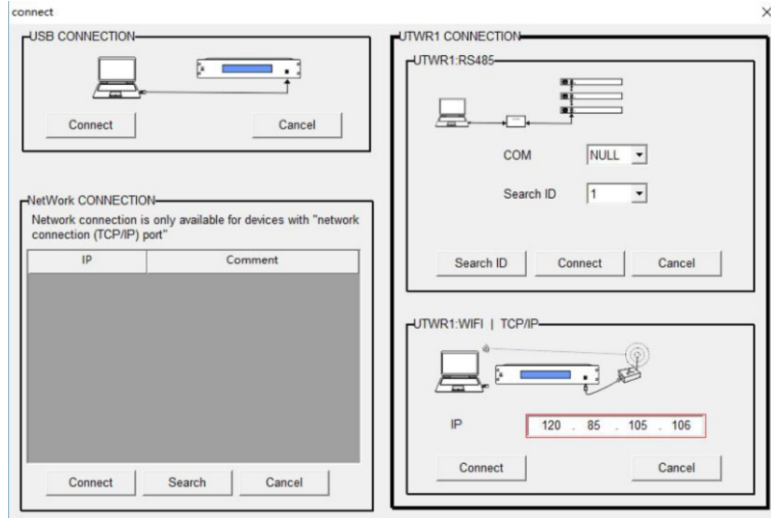

Pic 1.4.17

Open the software and click on “CONNECTION”, as the picture below, in the “Network Connection”, fill in the Internet IP address of the device.

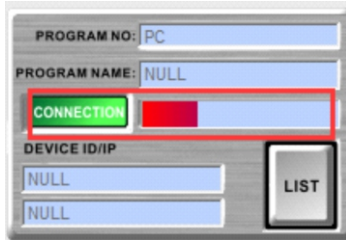

Pic 1.4.18

Click the button [Device], Display.

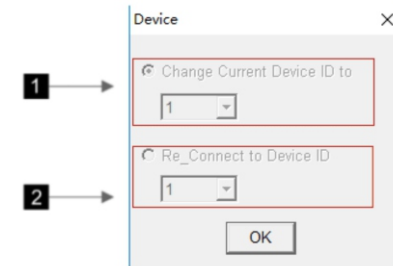

Pic 3.4.3.4.2

- 1 Modify the Device ID.
- 2 If there are multiple-device linked, please choose re-link to another device ID.

3.4.3.5 Modify the symbols on device`s display screen

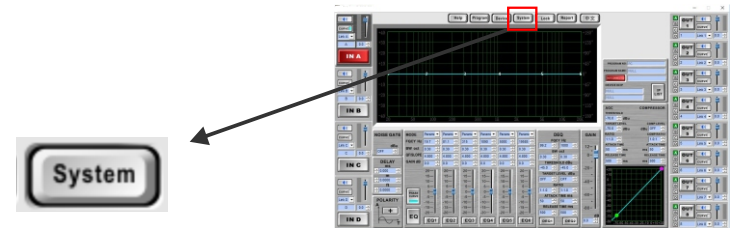

Pic 3.4.3.5.1

Click the button [system], Display.

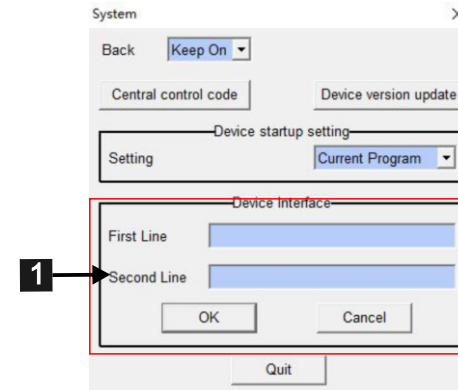

Pic 3.4.3.5.2

- 1 The display contents can be changed as below.

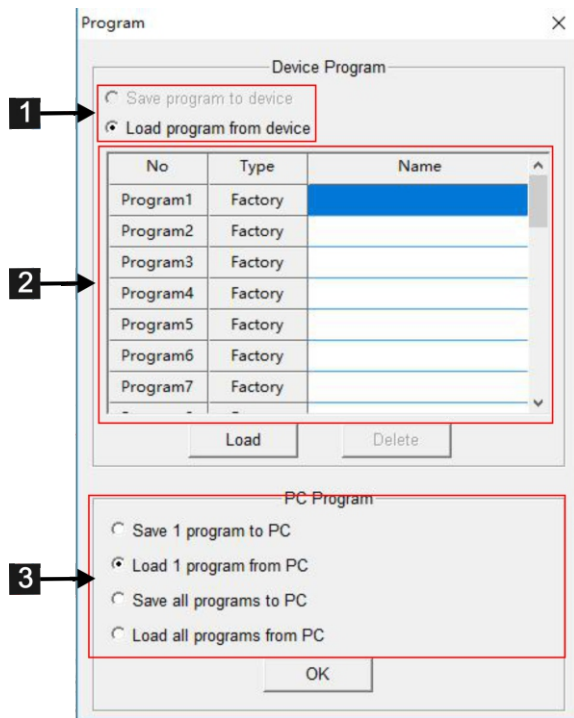

Pic 3.4 3.3.2

- 1 Data Program: Load and save selection in the saved Data.
- 2 List lists the data saved in the device, if the device saves data that can be displayed and can be specified in this number and name to save the data in this device or load data to the device, you can also specify a set of data to delete.
- 3 PC program: Load and save a selection in the saved computer Data

3.4.3.4 ID number modify & ID selecting in multiple devices connection

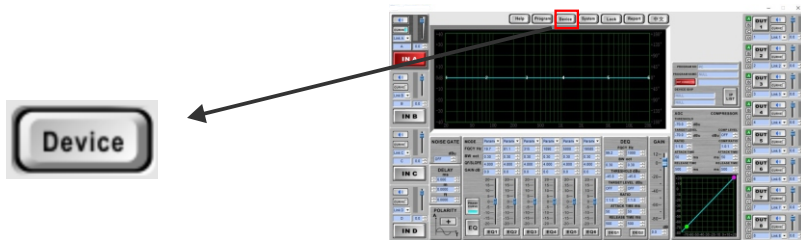

Pic 3.4.3.4.1

1.5 Terminal checking method

1.5.1 The method of checking the port of Windows 7
Click on "My Computer" will see below interface.

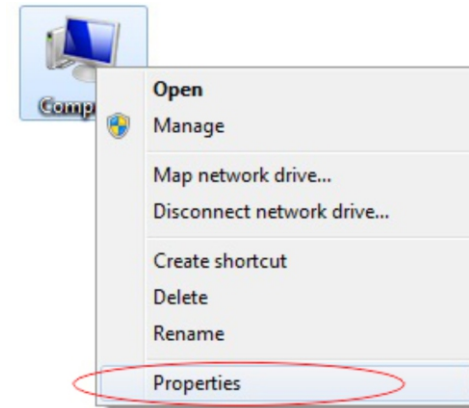

Pic 1.5.1.1

Click on "Attribute" will see the "Device manager" interface as pic. 1.5.1.2.

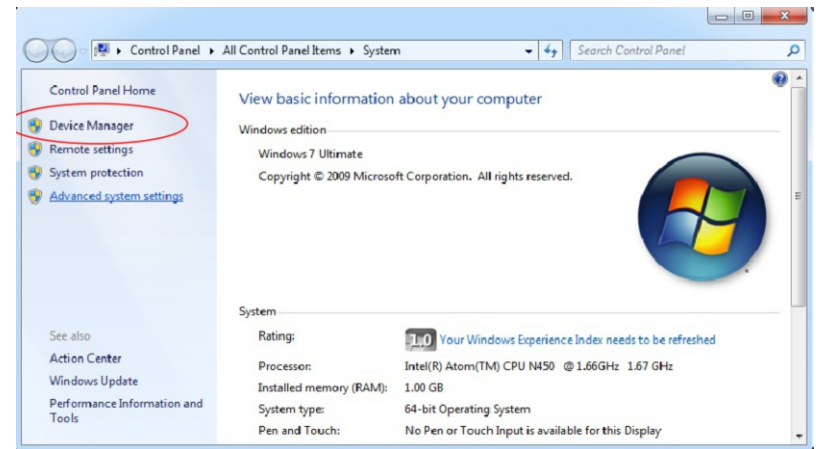

Pic 1.5.1.2

Click on “Device Manager” again, now you can check the corresponding port as pic, 1.5.1.3.

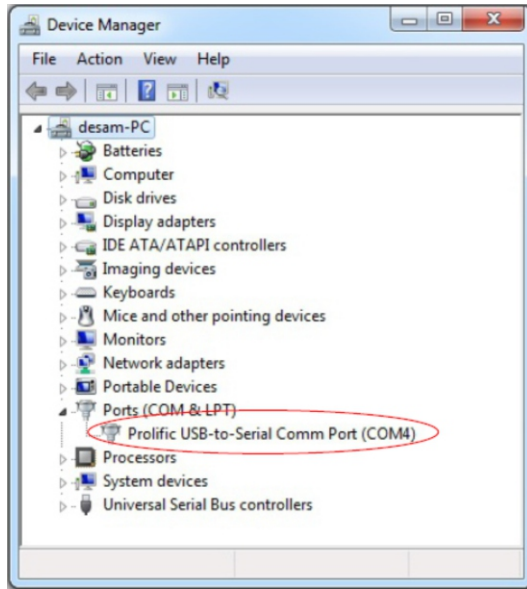

Pic 1.5.1.3

1.5.2 The method of checking the port of Windows 10
 Open the “Device Manager” enter method as follow.
 Click on “My Computer” will see below interface.

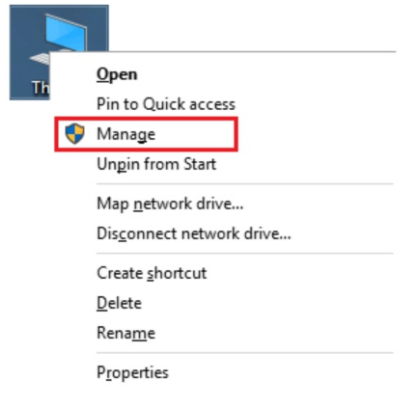

Pic 1.5.2.1

3.4.3.2 Instruction of output

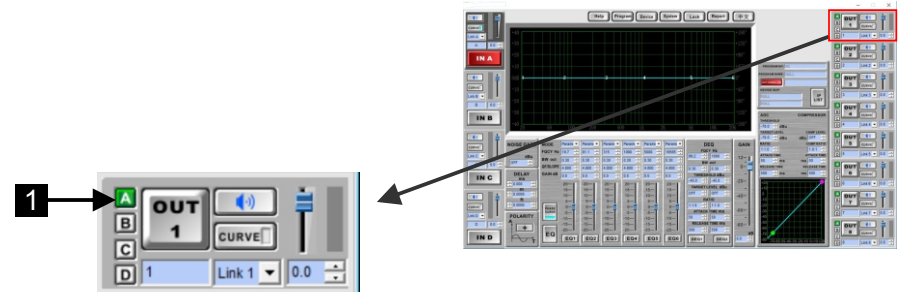

Pic 3.4.3.2.1

The picture above is a screenshot of an output selected channel, and similar to the input channel selection, but a matrix function added.

1 Matrix, A, B, C, D, representative of the 4 input channel.

3.4.3.3 Using/saving/of data

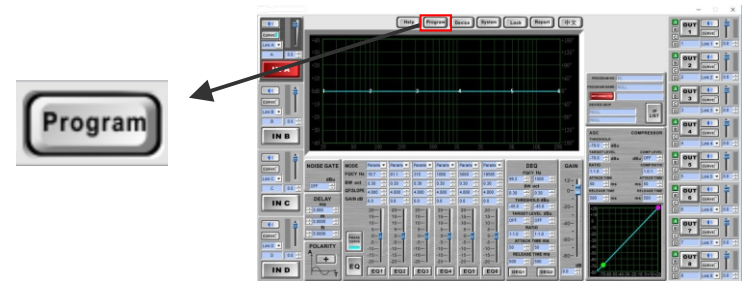

Pic 3.4.3.3.1

Click the button [Program], Display.

Note:

When the connection way is the first or second mode of 《1.4 Network Connection》 in the Wifi connection column, press {OK} to connect the device.(Note:In this time you need to set the IP address of the computer to automatic)

When the connection way is the third, fourth, fifth, sixth or seventh mode of the 《1.4 Network connection》, in the “Network connection” column, click {research} button. When the interface shows device researched, click {OK} button to connect the device.

3.4.3 About Software

3.4.3.1 Instruction of input

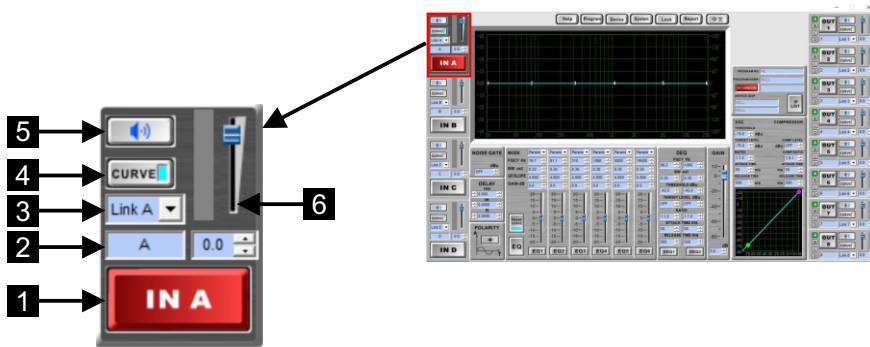

Pic 3.4.3.1.1

- 1 Channel buttons, red for the current channel being adjusted.
- 2 Label, express the name of the channel settings, if this channel is treble signals can be labeled “HIGH”.
- 3 Link, Link channels allows adjusting the parameters of several channels at the same time by using the same parameters on all of them. When link, in addition to “curve”, “mute”, “Label”, other parameters be changed at the same time.
- 4 [curve] button, the color of the button on the curve color, click [curve] button to turn off or turn on.
- 5 [mute]button, click [mute] button to close or open audio channel.
- 6 Gain adjustment, adjust the channel gain.

Click on “Manage” will see the “Properties” interface as pic, 1.5.2.2.

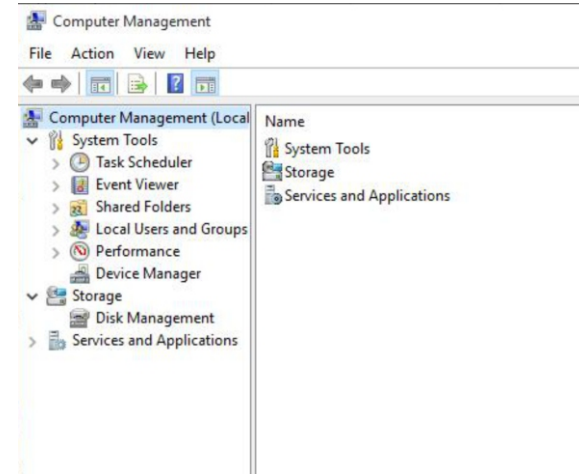

Pic 1.5.2.2

Click on “Device Manager” again, now you can check the corresponding port as pic, 1.5.2.2.

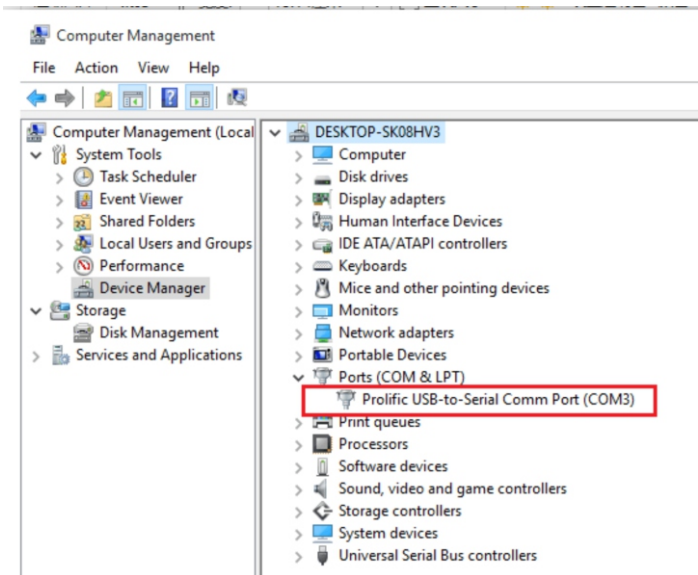

Pic 1.5.2.3

1.6 Parameter checking/parameter modify method

1.6.1 Check and modify the network connecting parameters of the device

1.6.1.1 The method of modifying the IP address under AP mode

For instance: Modify the IP address of the device to: 192.168.1.2.

Step 1: Use the first or second network connection method to connect the device, fill the device IP address in the IE browser, the default IP address as below.

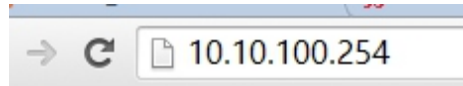

Pic 1.6.1.1.1

Press the “OK” button, the interface will look like this:



Pic 1.6.1.1.2

3.4.2 Software connection

① Open the software , Click [NOT CONNECTED] button

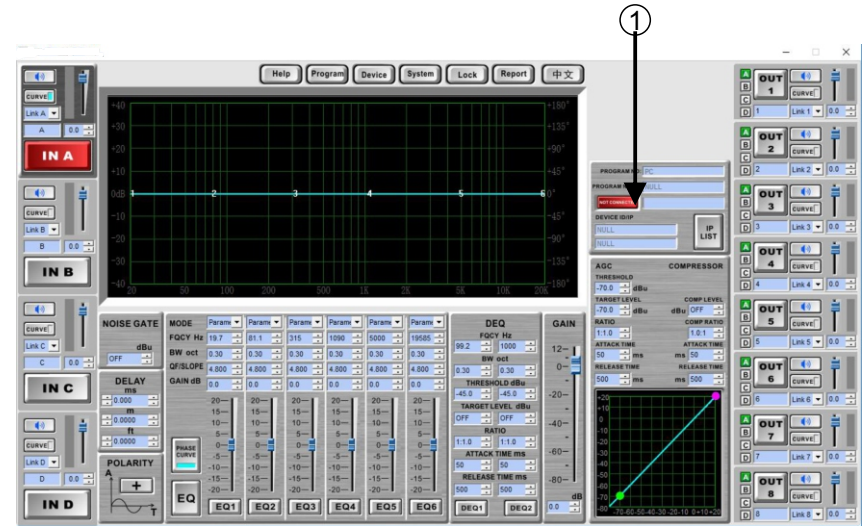

Pic 3.4.2.1

② pop-up connection window

1. When Connection way is “1.1 Single device connects with computer via USB and no need driver”, click the connect button in the “USB connection” bar to connect the device.
2. When Connection way is “over 1.2 devices connected to PC via UTWR1, in “UTWR1:RS485” column, select the appropriate port (port view, please refer to “1.5 port query methods”) and device ID press OK button to connect devices.

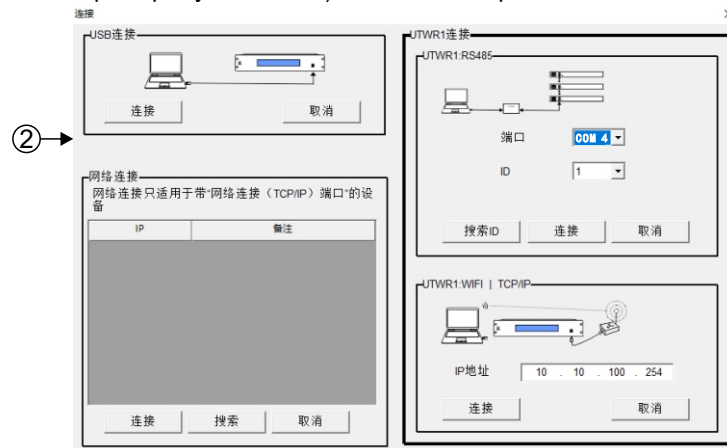

Pic 3.4.2.2

3.4 Software interface instruction

3.4.1 The 5 areas in software interface

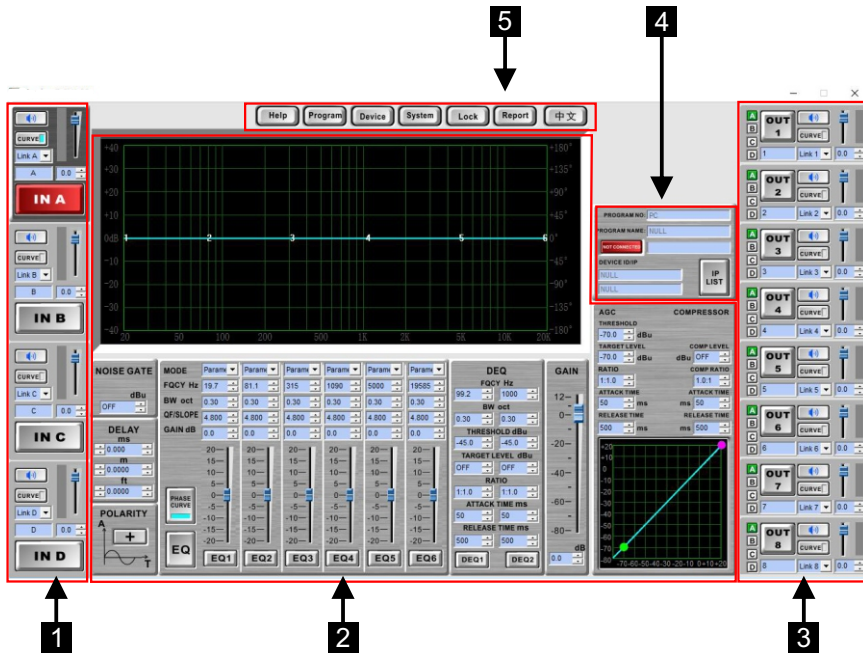

Pic 3.4.1.1

- 1** input channel selection area
Input channel selection, Link, label, curve, gain
- 2** channel editing area
Adjust the parameters of the regional channel in detail
- 3** output channel selection area
Input channel selection, Link, label, curve, gain, matrix
- 4** connection area
The connection area of the device
- 5** help setting

Step 2: Put in the user name: admin and password: admin, press the “OK” button to enter into the deployment interface as the picture below:

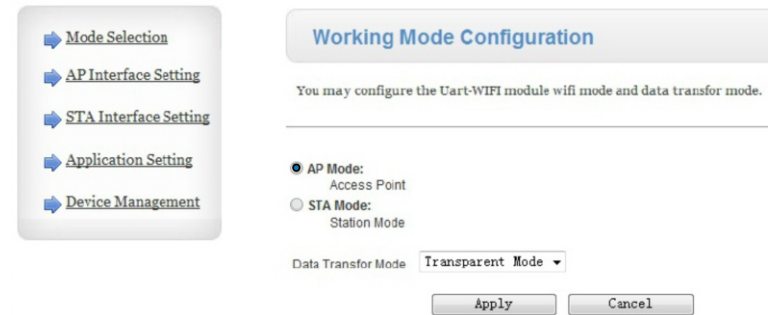

Pic 1.6.1.1.3

Step 3: Click on the “AP Interface Setting” at the left column:

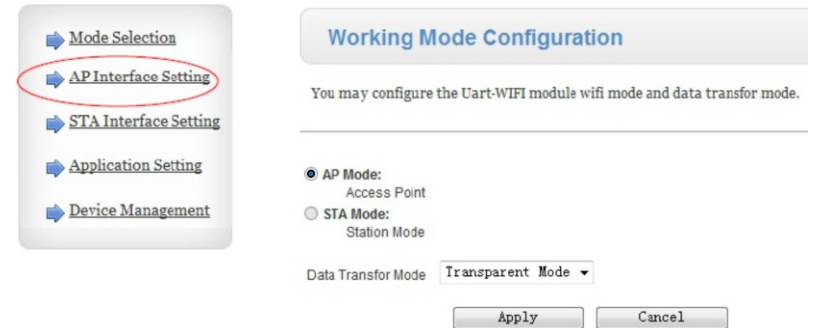

Pic 1.6.1.1.4

Step 4: Click on the “the setup of wireless access point” to enter into the interface as below:

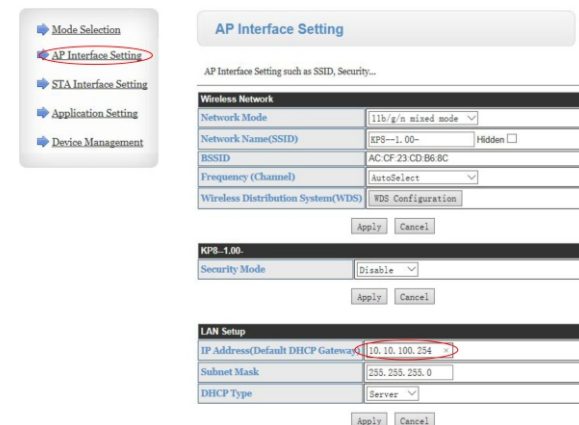

Pic 1.6.1.1.5

Step 5: As the interface above, modify the IP address which under the "LAN parameter setup" (The range of IP address is 0.0.0.0. to 255.255.255.255), press "OK" to finish the modification:

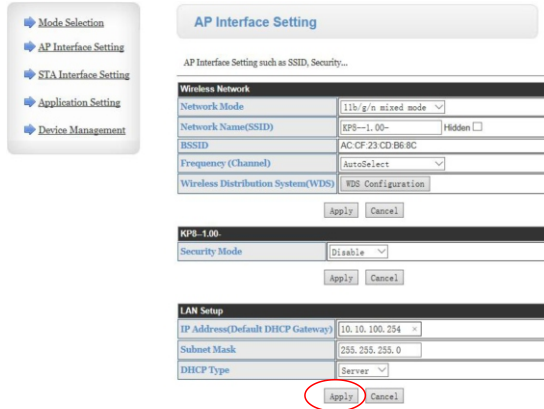

Pic 1.6.1.1.6

Step 6: Press "Apply" Enter into the interface as below:

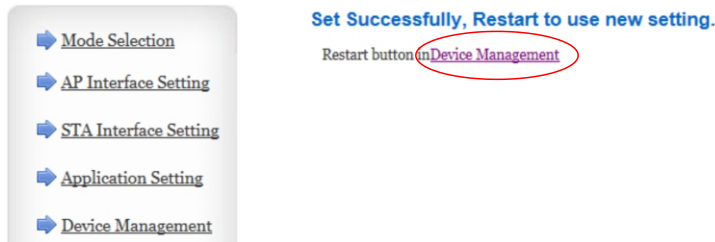

Pic 1.6.1.1.7

Step 7: Click on the "Device Management" enter into the interface as below:

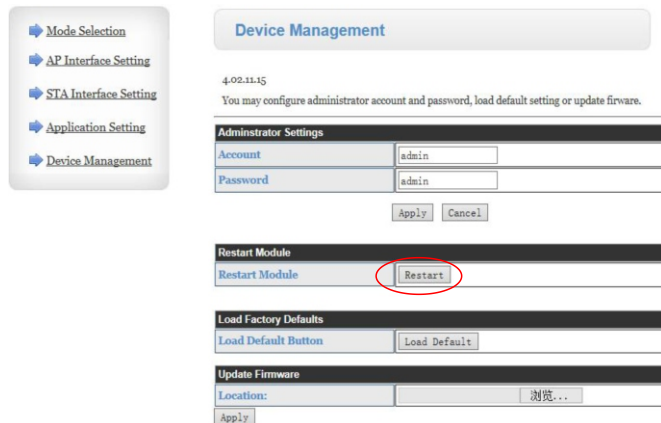

Pic 1.6.1.1.8

After restarting, now the device IP address is 192.168.1.2.

3.3 Solutions for the connection error

1. Computer, USB and device, any of them can cause the connection failure.
2. If several devices connect failure, probably is the RS485 connector problem.
3. Computer Problems:
 - a. USB port damaged, please use a new USB port for connection.
 - b. Can not detect the COM port, that means the USB drive installed wrong. Please reinstall the USB drive program, then connect again.
 - c. The software starts irregular, please close the software, and reopen the software connection again.
 - d. If it is the problem of computer system, please reinstall the system or change another computer to connect again.
4. USB wire problems:
 - a. If USB plug damaged, please change a new USB plug and connect again.
 - b. USB port not detected, please pull out the USB wire, insert and connect again.
5. Device problems:
 - a. Device not start yet, please start the device then connect again.
 - b. The device still under starting, not work under normal status, please press the channel button on the panel. If the button doesn't light up, that means the device still not work normally. Please wait for the device work normal then connect again.
 - c. If the USB port had a trouble, please apply for repairing.
6. UTWR1 converter problems:
 - a. If the cable of UTWR1 converter to the device failed, please change the cable and connect again.
 - b. If the UTWR1 converter damaged, please change the new converter and connect again.
7. IF cannot search the UTWR1 Module signal, the reason maybe as below: Check if the wireless mode is the AP mode or not, the modified method, please refer to "1.7.1.4 The method of changing the Station mode and AP mode."
8. The question of the software version and device version does not match: When the software version and device version does not match, the online error will appear, check the correspondence between the software version which is available at the official website, to download the corresponding software

Part 3: Software installing & instruction

For using the device for the first time, need to install 1, USB driver; 2, PC control software.

3.1 The installation of RS485 driver in UTWR1 model

Put the disk into the driver of PC. And open the file "AUDIO PROCESSOR" in it.

Name	Date modified	Type	Size
AUDIO PROCESSOR	7/24/2018 6:05 PM	File folder	

Pic 3.1.1

Open "USB_Driver" in the file , and install USB driver program.



Pic 3.1.2

(NOTE :The installation of RS485 driver in UTWR1 model no need to do any setting ,just press "next step"to finish the installing directly.)

3.2 Installing of software

Put the disk into the driver of PC . And open it to find the file "AUDIO PROCESSOR ",and copy "AUDIO PROCESSOR" to somewhere.

Name	Date modified	Type	Size
AUDIO PROCESSOR	7/24/2018 6:04 PM	File folder	

Pic 3.2.1

Open the file:AUDIO PROCESSOR.exe from AUDIO PROCESSOR to run the software.

Name	Date modified	Type	Size
AUDIO PROCESSOR.exe	7/24/2018 5:52 PM	Application	20,329 KB

Pic 3.2.2

1.6.1.2 The method of modifying the IP address under the Station mode

For instance: Modify the IP address to 192.168.1.2

Step 1: Connect the device to the network , put the IP address of the device in your internet browser or "My computer" (the default device IP address is 10.10.100.254) as below:

Note: check that the processor is connected to the computer successfully before modifying the IP address.

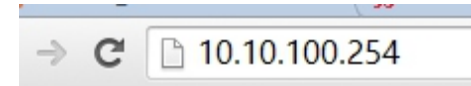

Pic 1.6.1.2.1

Press the "OK" button, the interface will look like as below:



Pic 1.6.1.2.2

Step 2: Put in the user name: admin and password: admin, press the "OK" button to get into the deployment interface as below:

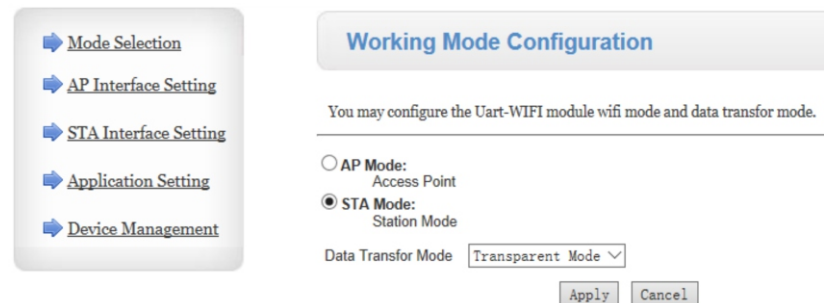

Pic 1.6.1.2.3

Step 3: Click on the “STA Interface Setting” and enter into the interface as below:

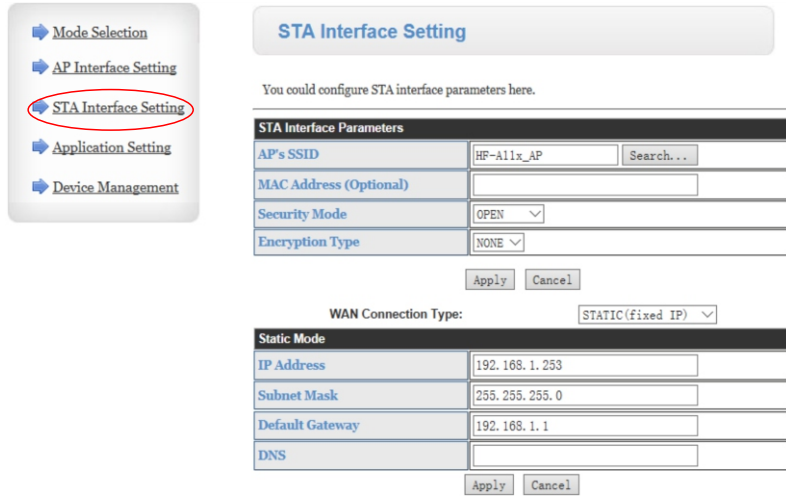

Pic 1.6.1.2.4

Step 4: At the “Setup of module IP address”, choose the “fixed IP” as the picture below:

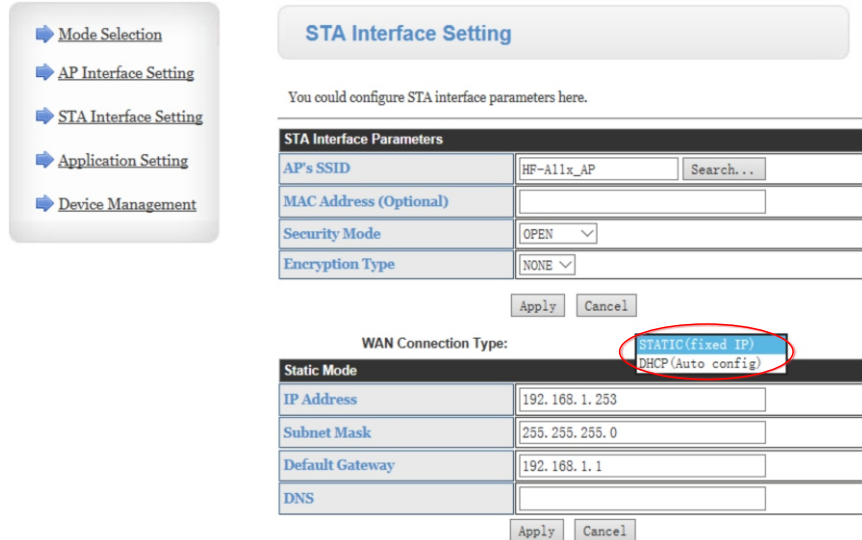

Pic 1.6.1.2.5

2.8.4 Copying the data of one channel to another channel

Referring to “2.8.1 Saving Program”.

Enter the menu {channel copy }to Copy the data of one channel to another channel. Click [Encoder] to come back to standby status.

2.9 Others

2.9.1 Multi-channel linking

For example :Setup Out 1 linking Out2 ,out3.

The parameters of them will change relatively.

(note: the combined channel must be either an input channel or an output channel).

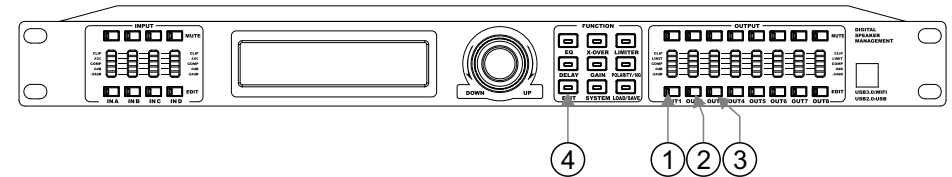

Pic 2.9.1.1

- ① Click [OUT],its yellow light will shine , and the system will enter automatically into the branch of EQ menu.
- ② Constantly click [OUT1] and [OUT2],[OUT3]'s yellow light will shine, too.
- ③ Constantly click [OUT1] and [OUT3],[OUT3]'s yellow light will be on, too. After this ,they are linking .When the parameter of [OUT1] will link [OUT]'s and [OUT3].
- ④ Click [EXIT] .Their lights are off and back to the original status.

2.9.2 Label

You can use PC software to add and modify the tag of each channel, and show the tag after channel number in the meantime.

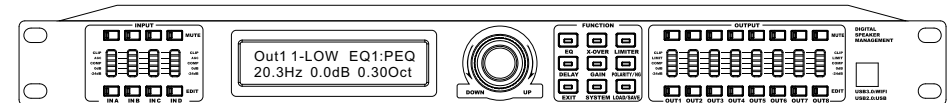

Pic 2.9.2.1

2.7.6 System information

At random condition ,pressing [system] to enter system menu .
Enter the menu {6.System Information} to check the system info (version)

2.7.7 Check device IP address

At random condition ,pressing [system] to enter system menu .
Enter the menu {7.TCP/IP Set} to check device IP address.

- (1)IP address set
- (2) Gateway address set
- (3) Device Name Set

2.8 Program operating

2.8.1 Saving the program

i.e. Saving the present parameter setup as program ,numbered it as 10 , and the title will be “my program 10”.

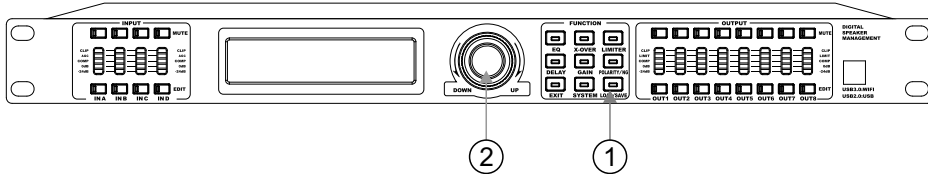

Pic 2.8.1.1

- ① At random status ,you can enter program menu by clicking [Load/ Save]
- ② Rotate [Encoder] to choose the branch menu{2. Save program}
Click the to enter into menu {2. Save program}
Rotate [Encoder] to choose menu {Save}
Click to enter menu {Save} the cursor will shine ,and rotate [Encoder] to choose No.10 .
Click the [Encoder], and input “my program 10”
Constantly click [Encoder]to show “Save successfully”
and it will be back to the standby status automatically.

2.8.2 Loading program

Referring to “2.8.1 Saving Program”
Enter the menu (Group Load) to find the program you need to load .

2.8.3 Erase the program

Referring to “2.8.1 Saving Program”
Enter the menu{2. Save program}
Rotate [Encoder] to choose default .
And enter the menu
and rotate [Encoder] to choose the program ID you need to eras.
Click [Encoder] to continue
or rotate [Encoder] to choose “No” to cancel the operation
Constantly click [EXIT] to come back to stanby status.

Step 5: After choosing “fixed IP”, enter into the interface as below:

- Mode Selection
- AP Interface Setting
- STA Interface Setting
- Application Setting
- Device Management

STA Interface Setting

You could configure STA interface parameters here.

STA Interface Parameters	
AP's SSID	HF-Allx_AP <input type="text" value="Search..."/>
MAC Address (Optional)	<input type="text"/>
Security Mode	OPEN <input type="button" value="v"/>
Encryption Type	NONE <input type="button" value="v"/>

WAN Connection Type: STATIC(fixed IP)

Static Mode	
IP Address	<input type="text"/>
Subnet Mask	<input type="text"/>
Default Gateway	<input type="text"/>
DNS	<input type="text"/>

Pic 1.6.1.2.6

Step 6: Fill in the corresponding parameters in the interface as below. The one item of IP address must be the same with the identical network segment of the router(The range of IP address is from 0.0.0.0~255.255.255.255).
For instance: The IP address of the router is 192.168.1.1, then the device IP address can be the one from 192.168.1.0 to 192.168.1.255, with the exception of 192.168.1.1(The IP of the router).
As the picture below, we set the IP address 192.168.1.3 for the device1, then fill it in the “SUBNET MASK” .

WAN Connection Type: STATIC(fixed IP)

Static Mode	
IP Address	<input type="text" value="192.168.1.3"/> <input type="button" value="x"/>
Subnet Mask	<input type="text" value="255.255.255.0"/>
Default Gateway	<input type="text" value="192.168.1.1"/>
DNS	<input type="text"/>

Pic 1.6.1.2.7



Step 7: Press “OK” and restart the UTWR1 module to finish the modification of IP address.

1.6.1.3 The method of checking the device IP address

1.6.1.3.1 The method of checking the device IP address under AP mode

Under the AP mode, the IP address is the UTWR1 module address, the checking method as follows:

Take the first or second network connecting method to connect the device Under the AP mode, the checking method of device IP address for Windows 7 system

Step 1: Click on the icon  /  you would see the interface as below:



Pic 1.6.1.3.1.1

Step 2: Click on “open the network and sharing center”.

wired connection

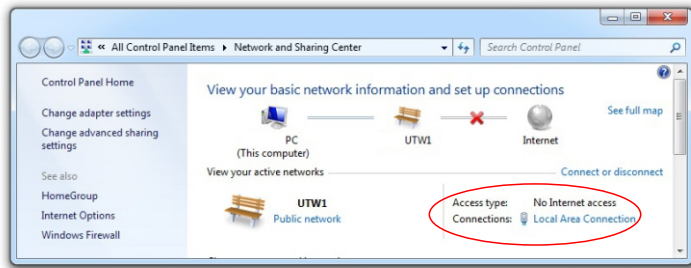

Pic 1.6.1.3.1.2

2.7.2.2 The phenomenon that the parameter is locked

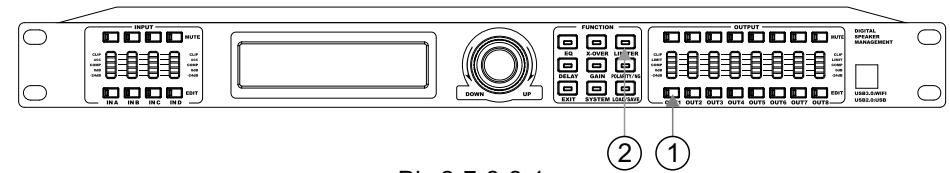

Pic 2.7.2.2.1

- ① Press [OUT1] and the system will enter into EQ1 branch menu of EQ menu naturally.
- ② Press [LIMITER] system ,and it will show {limiter locked }which show the output channel 1 's limiter is locked .Press [Exit] key until it come back to the standby status.

2.7.2.3 Modifying the locked item

Press [SYSTEM] enter into system menu Choose {2.Lock Menu Setup} and press (Encoder) enter into it. Choose the menu which needed to be modified {1.Input Set},{2.Output Set},{3.System Set} Press (Encoder)enter into submenu, if it has password put in the password, if no then enter directly. Rotate (Encoder) to choose {3.Change Lock Menu} Press (Encoder) and rotate it to choose modifying locked item. Press (Encoder) to enter into modifying locked. (ON) start, (OFF) shut down.

2.7.2.4 Modify and cancel the password

Press [SYSTEM] enter into system menu Choose the menu which needed to be modified {1.Input Set}, {2, Output Set}, {3, System Set} Press (Encoder) and input 6 number password then enter into menu. Rotate (Encoder),choose {1.Change Passwords} to modify the password. Press (Encoder) enter into modifying interface and input 6 number password twice then press (Encoder) to fishnish the modifying. Choose {2.Erase Passwords} and press (Encoder) to cancel the password.

Note: please be sure to remember password!!!

2.7.3 Power on setup

At random condition ,pressing [system] to enter system menu . Enter the menu {3.Power On Setup} to check the backlight setup.
 {A:Keep State}
 {B:ALL Mute}
 {C:Load Program 1: }

2.7.4 Backlight setup

At random condition ,pressing [system] to enter system menu . Enter the menu {4.Backlight Setup} to check the backlight setup.
 {1.Open}The LCD is always on.
 {2.10s}The backlight of the LCD is turned off after the unattended operation time of the device exceeds 10 seconds.

2.7.5 Current program

At random condition ,pressing [system] to enter system menu . Enter the menu {5.Current Program} to check the current program.

2.7.1 Change the Device ID

For example:
Change device ID to 5

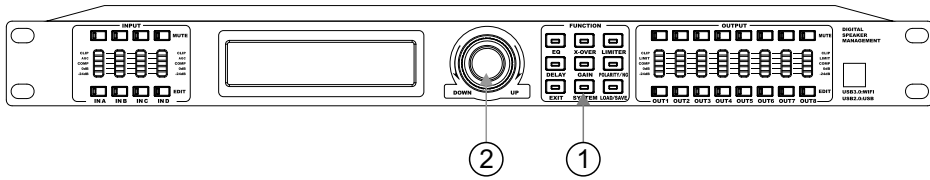

Pic 2.7.1.1

- ① At random condition, pressing [system] to enter system menu.
- ② Rotate [Encoder] to choose branch menu {Device ID Setup}
Press [Encoder] to enter the menu.
Rotate [Encoder] to Changing device ID into 5.
Press [Encoder] to confirm.
Constantly press [Exit] until it come back to standby status.

2.7.2 Lock menu setup

2.7.2.1 Lock output channel`s limiter demonstration

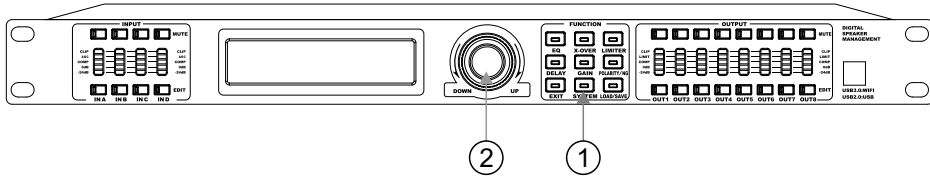

Pic 2.7.2.1.1

- ① At random condition, pressing [SYSTEM] to enter system menu.
- ② Rotate [Encoder] to choose branch menu {2.Lock Menu Setup}
Rotate [Encoder] to choose branch menu.
Rotate [Encoder] to choose branch menu {2.Output Set}
Rotate [Encoder] to choose branch menu.
Can choose {1.No Password} to set up no password. Press (Encoder)enter into {2.Create Password} directly and the cursor stay at {1}.setup the password with 6-digits
 - a. Cursor will shine at first letter, rotate (Encoder),and choose one letter.
 - b. Click (Encoder)to make the first letter of password and move the cursor to shine at the second letter.
 Repeat the action a and b to finish 6 number password
Then input the same password in{2.}
Keep press (Encoder) then release it when the interface shows password setting successfully it will enter into lock menu automatically.
Rotate (Encoder) to choose {7,Comp_Lim}
Press (Encoder) to make sure the cursor shine at {OFF} and rotate (Encoder) to choose {ON} and press (Encoder) to confirm this to finish the adjustment.
Constantly press [EXIT] until it comes back the standby status.

wireless connections

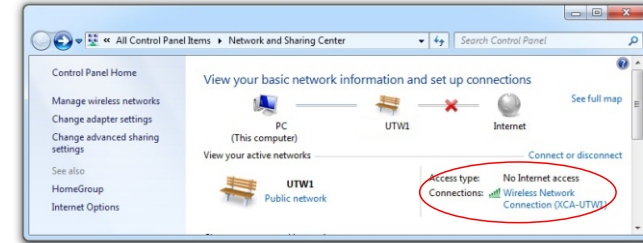

Pic 1.6.1.3.1.3

Step 3: Click on the red frame of the picture in Step 2, and you will see the interface as below:

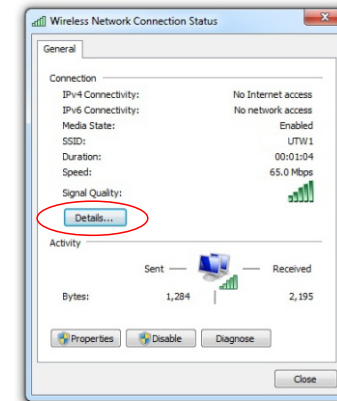

Pic 1.6.1.3.1.4

Step 4: Click on the red frame ("detailed information") of the picture in Step 3,you will see the interface as below, the red frame is the device IP address 10.10.100.254.

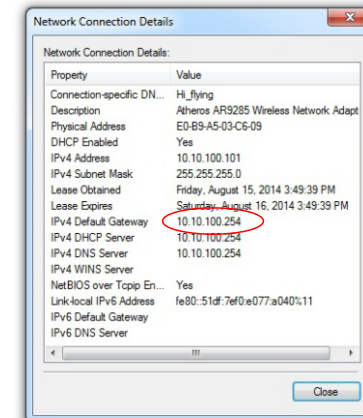

Pic 1.6.1.3.1.5

1.6.1.3.2 The method of checking the device IP address under the Station mode
Under the Station mode, the IP address is distribute by the router, so the IP address is not the UTWR1 IP address , and we need to enter into the UTWR1 module setup interface to check the IP address, the checking method as below:

Connecting the device , take the method of checking the IP address under the AP mode for reference, and check the UTWR1 IP address is 10.10.100.254

Step 1: Fill the IP address in the IE browser or “my computer” address bar as below:

Attention: Please be sure that the device has been connected the computer before modifying the IP address.

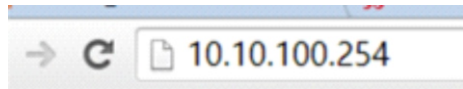

Pic 1.6.1.3.2.1

Step 2: Fill in the user name: admin and password: admin , press the “OK” button and enter into the deployment interface, find the interface as below , the IP address in the red frame is the device IP address under Station mode :192.168.1.2

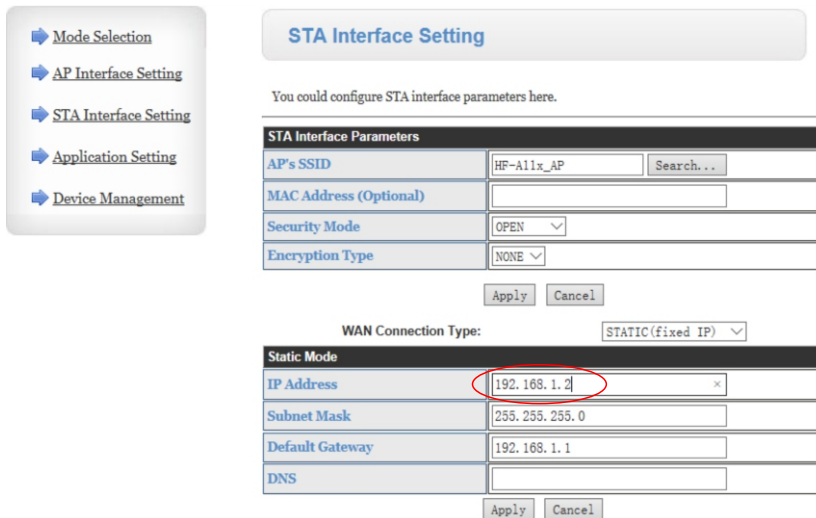

Pic 1.6.1.3.2.2

1.6.1.4 The method of changing the Station mode and AP mode

Use the network cable to connect the computer and UTWR1 module, and then open the browser, fill 10.10.100.254 in the address bar, and enter into the setup interface of UTWR1 module, the default user name and password is “admin”, log on and find “ mode selection” to select the needed mode as below:

2.7 System Menu

Press [system]to enter into system menu ,including the 7 branch menu :

1.Device ID Setup

PC software choose the relative device by device ID .

2.Lock Menu Setup

After setup the parameter , to prevent other from modifying parameter ,the user can setup the lock parameter to realize it ,set up the password with 6 digits .

The parameter can be locked :

INPUT LOCK	OUTPUT LOCK	SYSTEM LOCK
1.LABEL	1.LABEL	1.LOAD PROGRAM
2.MUTE	2.MUTE	2.SAVE PROGRAM
3.DELAY	3.DELAY	3.DELETE PROGRAM
4.POLARITY	4.POLARITY	4.COPY PROGRAM
5.GAIN	5.GAIN	5.DEVICE ID
6.NOISEGATE	6.MATRIX	6.INTERFACE
7.AGC_COMP	7.COMP_LIM	7.BACK LIGHT
8.DEQ	8.EQ	8.KEY EDIT
9.EQ	9.X-OVER	9.POWER ON
10.LINK	10.LINK	10.ALL LOCK
11.ALL LOCK	11.ALL LOCK	

3. Power On Setup

Setup the additional action when power on.

- (1) Keep State
- (2) All Mute
- (3) Load

4. Backlight Setup

LCD backlight setup

- (1) Keep On: shining
- (2) 10s: the operation time is more than 10s, and turn it off.

5. Current Program

Check the title of the current loaded program.

6. System Information

Check system version info.

7. TCP/IP Set

Check system IP

- (1) IP address set
- (2) Gateway address set
- (3) Device Name Set

Output EQ	Each output channel has a 6-band EQ, 6 modes: PEQ/Lo-Shelf/Hi-Shelf/APF 1st/APF 2nd A. The adjusting parameters under PEQ condition are: central frequency point: 19.7 Hz 20 kHz, bandwidth of 241 frequency points: 0.05 oct/3 oct. The step distance is 0.01oct gain: -20dB ~ 20dB, step distance is 0.1dB B. The adjustable parameters in Lo-Shelf and Hi-Shelf are: central frequency point: 19.7 Hz-20kHz, a total of 241 frequency point slope: 1: 6dB / 12dB gain: -20dBu-20dBuand step distance: 0.1dB C. In APF 1st state, the central frequency is 19.7 Hz and 20kHz, a total of 241 frequency points are optional. D. The adjusting parameters under APF 2nd state are: central frequency point: 19.7 Hz: 20kHz, total bandwidth of 241 frequency points: 0.05oct / 3oct.The step distance is 0.01oct.
Processor	96KHz sampling frequency, 32-bit floating-point DSP,24-bit A / D and D / A conversion
Display	2 × 24 LCD blue backlight display setting 5 segments LED display accurate digital level meter, mute and edit status for input / output
Power	≤ 25W
Power supply	AC110V/220V 50/60Hz
Product dimension (WxDxH)	482×190×44mm
Net weight	4.25kg
Shipping Dimension (WxDxH)	1PC:562X296X98mm/0.0163m ³ 6PCS:578X308X615mm/0.1094m ³
Gross weight	1PC:4.5(kg) 6PCS:28.5(kg)

2.6 Editing method for input & output channels

The input and output channel have similar editing method as below:

Firstly: Choosing input or output channel :pressing the editing key (i.e. INA or OUT1).

Secondly: choosing the function key you need to edit 9 i.e. EQ, X-over).

Thirdly: choosing and rotating Encoder to adjust parameter .

Finally: Quit and save .

For example :

Adjusting EQ 3 's parameter as frequency :397 Hz ,gain:2dB,Q value:0.80oct.

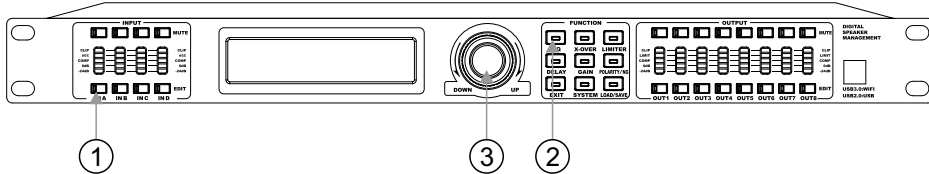

- Pressing the [INA], its yellow light shine ,and the system naturally enter into EQ menu 's EQ1 .
- Clicking [EQ] , the branch menu will change between EQ1 and EQ6 ,and choose EQ3.
- Cursor will shine at frequency value , and rotate Encoder to adjust frequency into {397 Hz}. Click [confirm] to setup frequency value , and the cursor will skip to gain value to shine . Re-rotate Encoder to adjust gain as {+ .0dB}, and re-click [confirm]to setup gain value , which make cursor skip to Q value to shrink . Finally ,rotate Encoder to adjust Q value as {0.80 Oct } . Click [Exit]to come back to standby status , and INA 's yellow light is off .

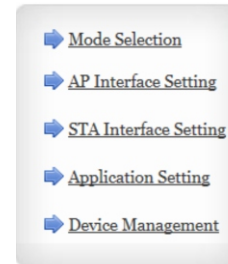

Working Mode Configuration

You may configure the Uart-WIFI module wifi mode and data transfer mode.

AP Mode:
Access Point
 STA Mode:
Station Mode
Data Transfer Mode:

Pic 1.6.1.4.1

1.6.2 Check and modify the device ID

Check the ID

Take the "1.2 Multiple devices connecting with computer via UTWR1 " for reference to connect one device and computer, check the ID number of the device as below:



Pic 1.6.2.1

Click on the red frame button, enter into the interface as below:

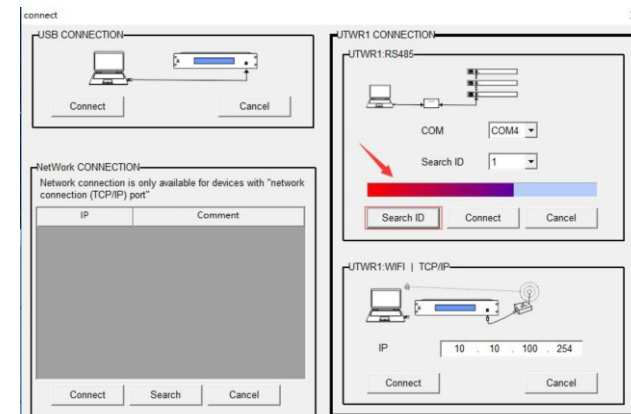

Pic 1.6.2.2

Click on the “Search ID” button at the interface as above, after finishing search, the ID in the red frame is the device ID number as below:

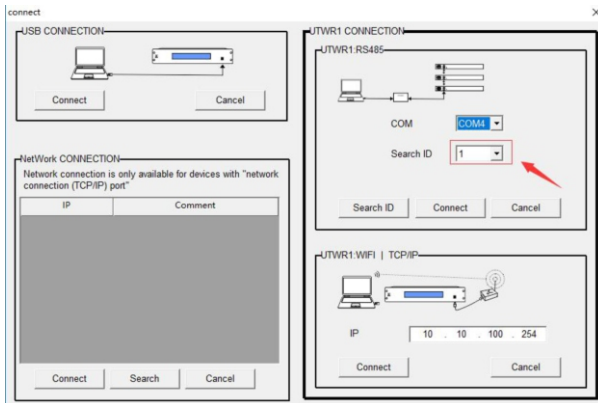

Pic 1.6.2.3

Modify the ID

For instance: modify the ID number to be “5”

After connecting the control software and device, click on “device ID”, you will see this:

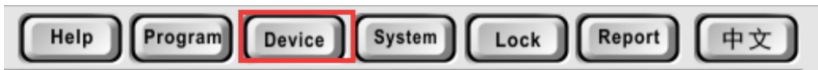

Pic 1.6.2.4

In the interface as below, at “Change Current Device ID”, choose “5”, and press the “OK” button to finish the modification.



Pic 1.6.2.5

2.5 Technical parameter

model	2in4out	2in6out	2in8out	3in6out	4in6out	4in8out
Input channel jacks	2CHs, Female XLR	2CHs, Female XLR	2CHs, Female XLR	3CHs, Female XLR	4CHs, Female XLR	4CHs, Female XLR
Output channel jacks	4CHs, Male XLR	6CHs, Male XLR	8CHs, Male XLR	6CHs, Male XLR	6CHs, Male XLR	8CHs, Male XLR
Input impedance	Balanced:20KΩ					
Output impedance	Balanced:100Ω					
PC port	There is 1USB port on the front panel (USB3.0 port can be extended to WIFI port), and 2 Rs485 ports on the rear panel(RJ-45)					
CMRR	>70dB(1KHz)					
Input range	≤+16.3dBu					
Frequency response	19.7Hz-20KHz(±0.5dB)					
S/N R	>104dB					
THD	<0.001% OUTPUT=0dBu/1KHz					
Crosstalk of channels	>106dB(1KHz)					
Functions of input channels						
Input Noise Gate	Each input channel has a noise-gate function, threshold quantity: -120dBu~0dBu, step: 1dBu					
Input mute	Mute with each input & output channel.					
Input gain	Input gain range: -80dB~+12dB, step: 0.1dB					
Input delay	Each input channel has a separate delay control, adjustable range of 0-1000ms, The step distance of fine tuning is 21us. the coarse step distance is 1ms					
Input polarity	In-phase(+)+or reversed phase (+/-)					
Input EQ	Each input channel of 6 parametric EQ,EQ type PEQ/Lo-Shelf/Hi-Shelf/APF 1st/APF 2nd A. The adjusting parameters under PEQ condition are: central frequency point: 19.7 Hz 20 kHz, bandwidth of 241 frequency points: 0.05 oct3 oct.The step distance is 0.01oct gain: -20dBu-20dBuand 0.1dBu. B. The adjustable parameters in Lo-Shelf and Hi-Shelf are: central frequency point: 19.7 Hz-20kHz, a total of 241 frequency point slope: 1: 6dB / 12dB gain: -20dBu-20dBuand step distance: 0.1dBu C. In APF 1st state, the central frequency is 19.7 Hz and 20kHz, a total of 241 frequency points are optional. D. The adjusting parameters under APF 2nd state are: central frequency point: 19.7 Hz: 20kHz, total bandwidth of 241 frequency points: 0.05oct / 3oct.The step distance is 0.01oct.					
Input dynamic equilibrium	Each input channel has two dynamic equalization, which can be adjusted as follows: frequency turning point: 19.7 Hz / 20kHz, a total of 241 frequency points bandwidth: 0.05oct3oct step distance is 0.01oct. Target level value: -45dBu-15dBu. The threshold value is: -45dBu. 15dBu. Ratio: 1.0: 1: 20: 1, 1.0: 1 to 1:2 step 0. 1: 1: 2 to 1:20 step 0.5. Response time: 0.3ms / 200ms, when it is smaller than 1ms, the step distance is 0.1ms, when it is larger than 1ms, it is larger than 1ms. And the step distance is 1 Ms. Release time: 50ms / 5000ms step 1ms					
Input Compression	Each input channel has a separate input compression setting. The adjustable parameters are: Compression level: -40dBu ~ 20dBu, step distance is 0.1dBu. Ratio: 1.0: 1: 20: 1, 1.0: 1 to 1:2 step 0. 1: 1: 2 to 1:20 step 0.5. When the response time is 0.3ms / 200ms, when the response time is smaller than 1ms, the step distance is 0.1ms, and when 1ms is larger than 1ms, the step distance is 1ms. Release time: 50ms / 5000ms step 1ms					
Input automatic gain	Each channel has a separate input automatic gain function. The adjustable parameters are: threshold value: -80dBu-20dBuand step 0.1dBu. Target level: -80dBu-20dBu. Ratio 1: 1: 1: 1: 20: 1: 1: 1 to 1:2 step 0. 1: 1: 2 to 1:20 step 0. 5. The response time is 0.3 ~ 200ms, when the response time is smaller than 1ms, the step is 0.1ms. when the response time is larger than 1ms, the step is 1ms. Release time: 50 / 5000ms, step 1 ms.					
Functions of output channels						
Output mute	Each channel has independent mute control.					
Output selection	Each input channel can be selected to each output channel.					
Output gain	Range:-80db~+12db, step: 0.1dB					
Output delay	Each input channel has a separate delay control, adjustable range of 0-1000ms,The step distance of fine tuning is 21 us. the coarse step distance is 1ms.					
Output polarity	Same phase (+/+) or reversed Phase (+/-).					
Crossover	Each output channel can be independently set as LPF or HPF. These parameters can be adjusted. Filter type: Linkwitz-Riley; Bessel; Butter worth Frequency turning point: 19.7Hz-20KHz,A total of 241 frequency points: A. Under the condition of Bessel and Butter, the slope of attenuation is reduced:12dB/oct, 18dB/oct, 24dB/oct,30dB/oct,36dB/oct,42dB/oct, 48dB/oct. B. In the Lin-Ril state, the attenuation slope: 12dB/oct,24dB/oct,36dB/oct,48dB/oct.					
Limiter	Each output channel can set the limiter separately. The adjustable parameters are: threshold value: -40dBu ~20dBu, step distance is 0.1dBu. The response time is 0.3 ~ 200ms, when the response time is smaller than 1ms, the step is 0.1ms. when the response time is larger than 1ms, the step is 1ms. Release time: 50 / 5000ms, step 1 ms.					
Output Compression	Limiter present for each output channel, These parameters are adjustable: Compression level: -40dbu~+20dBu, step:0.1dBu. Ratio: 1.0: 1: 20: 1, 1.0: 1 to 1:2 step 0. 1: 1: 2 to 1:20 step 0.5. When the response time is 0.3ms / 200ms, when the response time is smaller than 1ms, the step distance is 0.1ms, and when 1ms is larger than 1ms, the step distance is 1ms. Release time: 50ms / 5000ms step 1ms					

2.4 Rear panel instruction

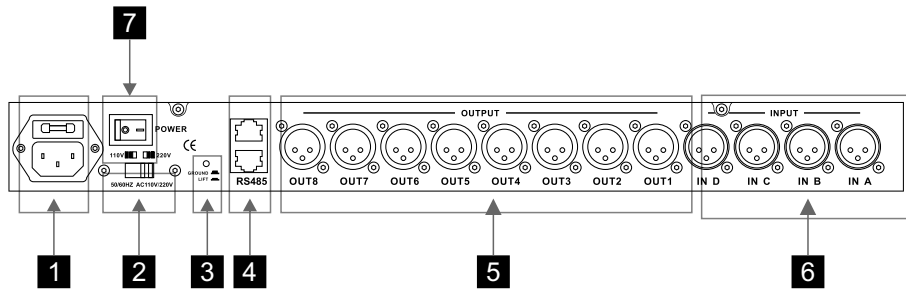

Pic 2.4.1

1 Exchanging current input socket

Inserting the relative AC input voltage, according to the shift indicator of power transfer switch.

2 Power transfer switch Choosing the relative input voltage gear(110V/220v)

Warning be sure to select the input according to the ac input voltage (110V/220V) voltage gear, such as the wrong choice will may damage the device

3 wire strobe switch

lthe connection and disconnection of the cabinet earth and signal earth by the control of this switch.

4 RS485 Port

Rs485 ports can be connected in series with network (up to 250 ports) and then Rs485 ports of any device can be selected . All serial devices can be remotely controlled by USB to UTWR1 module and computer connection.

5 Output Channel

8 output channel, labeled as OUT1-8,namely the first, second, ...eighth channel.

6 Input Channel

4 input channel, labeled INA-IND, namely the A, B, C, D channe.

7 Power switch

Connect the input voltage labeled by power transfer switch, and click the switch to work well.

Part 2: Operating instruction

2.1 The symbol explanation

1. [] is the panel button
2. { } is the LED content
3. 1 2 3 is the function indicating
4. ① ② ③ is the operation steps

2.2 Functions & Characteristics

1. 96 KHZ sampling frequency, 32-bit DSP processor,24-bit A/D and D/A converter.
2. 6 models available:2 ins/4 outs, 2 ins/6 outs, 2 ins/8 outs, 3 ins/6 outs, 4 ins/6 outs, 4 ins/8 outs. The high pass frequency point and low pass frequency point can up to 20Hz ~20KHz.
3. Provides USB2.0,USB3.0, and Rs485 ports to connect the computer, it can connected up to 250 sets by the Rs485 port. The connection distance can be up to 1500 meters.
4. Directly use the panel button and the coder or the PC control software to setup the function.
5. The device can store 30 user programs.
6. Set a password to lock the device parameters via the “system” button of the panel.
7. Each input channel and output channel has a 6-band independent PEQ , the adjustment range of gain is up to 20dB. And Lo-shelf and Hi-shelf are available for the EQ of output channel.
8. Each input channel has 2-band parameter adjustable DEQ .Delay can be adjusted by gross and fine tuning modes.
9. 2x24 LCD with blue color back light function , and the 5-band LED can display the input/output level precisely or mute/edit state.
10. Each input and output channel has the functions of delay , polarity control and mute . The delay can up to 1000ms, the unit can be ms , m and ft.
11. The output channel can control the gain and limit functions , also can select the input signal and copy all the parameters of one channel to another channel, then control the two channels together.
12. Control the matrix and channel mute by connecting the Rs485 and central system.
13. Support device input , output and system functions to set passwords for locking , to achieve data confidentiality.
14. Device software built-in control code generator , can realize on-click English-Chinese switching.
15. The computer can be connected by an external WIFI box, and remove control can be realized through the Internet.

2.3 Front panel instruction

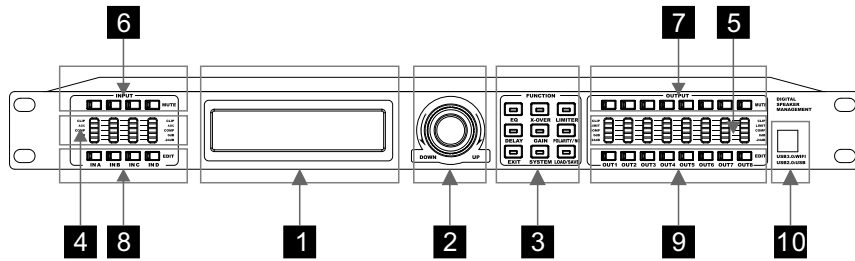

Pic 2.3.1

1 LCD display screen

Display the operation interface and menu.

2 Coder

- (1)Turn clockwise: The parameter increases / next option
- (2)Turn counter-clockwise: The parameter decreases / previous option
- (3)Short press: [ok] button
- (4)Long press: special confirmation

3 The menu information

- (1)[EQ] (2)[X-OVER] (3)[LIMITER]/[COMP]/[AGC]
- (4)[DELAY] (5)[GAIN] (6)[POLARITY/NG]
- (7)[EXIT] (8)[SYSTEM] (9)[LOAD/SAVE]

Under the parameters edit state, press (1)(2)(3)(4)(5)(6) .

will enter into the corresponding menu.

Under any state , press (7) will return or cancel the operation.

Under any state, press(8) (9) will enter into the system menu.

4 Input LED indicator light

A 5-levels LED bar-panel displays precisely the input data.

- (1)CLIP (clip). This light shows that the signal is distorted (red light).
- (2)AGC(AGC). This light shows the expansion function is working(pink light).
- (3)COMP (compression). This light shows the compression function is working (yellow light).
- (4) -24dB-0dB 2-band LED level indicator (green light).

5 Output LED indicator light

The LED meter shows the input figure with 5 segments and editing status.

- (1) CLIP (clip) show, the light will be open (RED)when signal distort.
- (2) Limit show ,the light turn to be orange.
- (3)COMP show , the light turn to be yellow.
- (4) -24 dB -0dB two section LED meter show (Green).

6 Input Mute

Press [IN A], [IN B],...[IN D] Mute/non-mute transfer Mute, the red light shines; non-mute, it closes.

7 Output Mute

Press [OUT 1], [OUT 2],...[OUT 8] Mute/ non-mute transfer Mute, the red light shines; non-mute, it closes.

8 Input channel function edition

INA [EDIT], INB [EDIT],...IND [EDIT] when editing, please refer to “Output control function setup”.

9 Output channel function edition

OUT1 [EDIT], OUT2 [EDIT],... OUT8 [EDIT] When starting to edit, please refer to “ Output control function setup”.

10 USB port

Adjusting the relative parameter through PC interface software (Compatible USB2.0, USB3.0).

Through USB 3.0 cable connection UTWR1 module, which can control the network connection, the remote control of the Internet.